



STAUFF Test

Test couplings, test hoses and accessories
for pressure monitoring and more

Product Catalogue

Version
10/2025

Germany

Walter Stauffenberg GmbH & Co. KG

Im Ehrenfeld 4
58791 Werdohl

www.stauff.com

STAUFF products and services are globally available through wholly-owned subsidiaries and a tight network of authorised distributors and representatives in all major industrial regions of the world.

You can find detailed contact information on the last two pages of this product catalogue or at www.stauff.com/contact.

Please note: Unless otherwise stated, all data and figures in this product catalogue are approximate values and are only valid as references, which are not binding (also in respect to any third parties' rights of protection) and thus do not release the customer / user from checking and testing the suitability of the products for the foreseen purposes. Therefore, data and figures can only be used in a limited sense for construction purposes.

The application of the products is beyond the control possibilities of the manufacturer and, therefore, is exclusively subject to the responsibility of the customer / user.

In the event that a liability is nevertheless considered, any compensation will be limited to the value of the goods supplied by the manufacturer and used by the customer / user. As a matter of course, the manufacturer guarantees the perfect quality of all products in accordance with the General Terms and Conditions of Business and Sale.

Subject to modifications due to the ongoing development and improvement of the products.

With the publication of this product catalogue, previous editions are no longer valid.

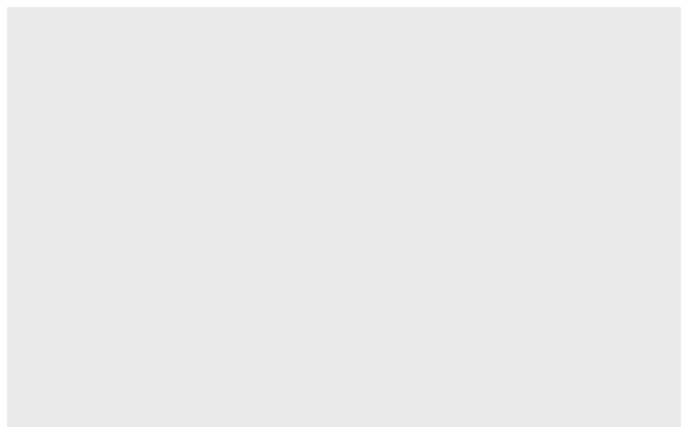
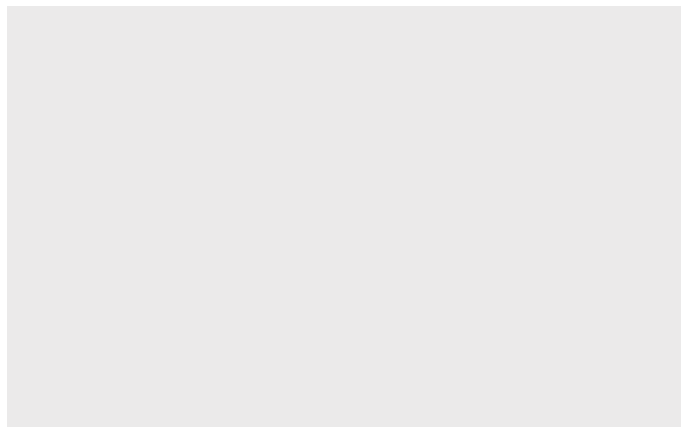

Introduction	4 - 11	
Test Couplings	12 - 53	A
Test Adaptors	54 - 59	B
Test Hoses and Connectors	60 - 71	C
Technical Appendix	72 - 77	D
Appendix (Product-Specific Abbreviations)	79 - 80	



Catalogue 1 STAUFF Clamps

- Block Clamps
- Special Clamps
- Light Series Clamps
- Saddle Clamps
- U-Bolt Clamps
- Metal Clamps
- Construction Series



Catalogue 2 STAUFF Connect

- Tube Connectors
- Assembly Tools and Devices



Catalogue 3 STAUFF Flanges

- SAE Flanges
- Gear Pump Flanges



Catalogue 4 STAUFF Hose Connectors

- Hose Connectors
- High-Pressure Hose Connectors



Catalogue 5 STAUFF Quick Release Couplings

- Push-to-Connect Couplings
- Multi Couplings
- Screw-to-Connect Couplings



Catalogue 6 STAUFF Valves

- Two-Way Ball Valves
- Multi-Way Ball Valves
- Flow Control and Check Valves
- Gauge Isolator Valves



Catalogue 7
STAUFF Test

- Test Couplings
- Test Adaptors
- Test Hoses and Connectors



Catalogue 8
STAUFF Diagtronics

- Pressure Gauges
- Hydraulic Testers
- Oil Analysis Equipment



Catalogue 9
STAUFF Filtration Technology

- Replacement Filter Elements
- Pressure Filters
- Return-Line Filters
- In-Line Filters
- Spin-On Filters
- Offline and Bypass Filters
- Filtration Systems



Catalogue 10
STAUFF Hydraulic Accessories

- Fluid Level and Temperature Indicators
- Tank Filler Breathers
- Giant and Desiccant Air Breathers
- Suction Strainers
- Diffusors

For more than 50 years, the companies of STAUFF Group have been developing, manufacturing and distributing pipework equipment and hydraulic components for mechanical and plant engineering and for service and industrial maintenance.

In addition to mobile and industrial hydraulic machinery, typical applications also include commercial and special purpose vehicles, rail transportation and energy technology. Likewise, STAUFF products are used in marine, oil and gas applications and in the process, food and chemical industries.

The overall range currently includes about 50000 standard products as well as numerous special and system solutions according to customer's specifications or based on our in-house development.

All STAUFF products undergo relevant testing in accordance with international regulations and are governed by the high standards of the in-house quality management system. Furthermore, many items have received certifications and approvals from various international institutes, organisations and authorities who have independently confirmed the quality and performance of the products.

Wholly-owned manufacturing, sales and service facilities in 18 countries and a tight global network of authorised distribution partners ensure high presence and service paired with a maximum of availability.



Quality Management – ISO 9001:2015
Environmental Management – ISO 14001:2015
Safety Management – ISO 45001:2018
Energy Management – ISO 50001:2018

STAUFF LINE Components

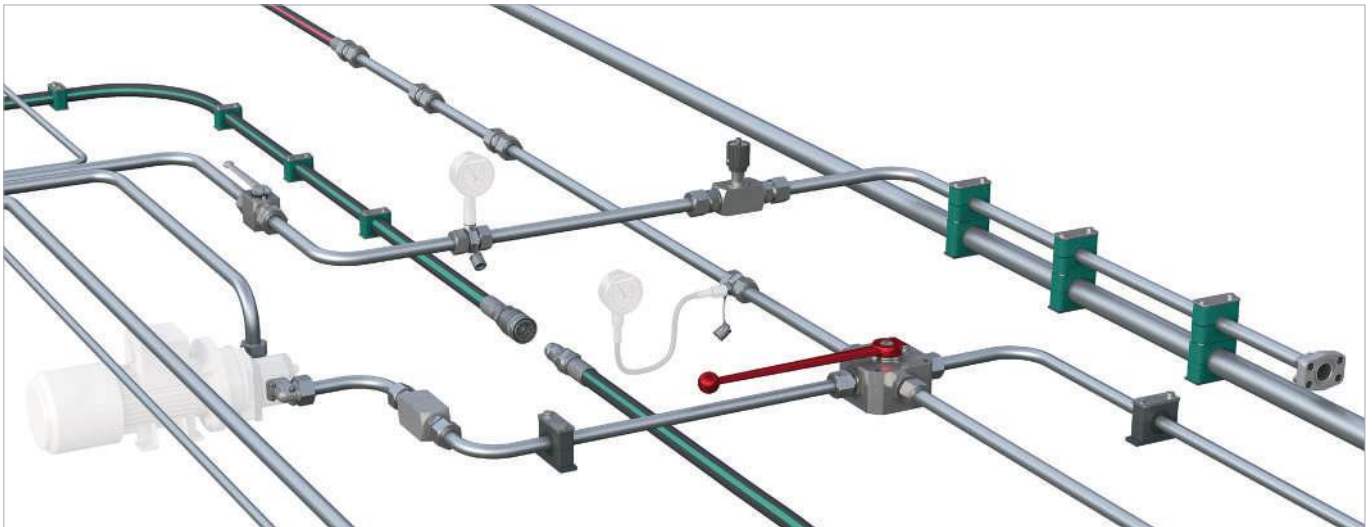

With the seven dedicated **STAUFF Line** product groups

- **STAUFF Clamps**
- **STAUFF Connect**
- **STAUFF Flanges**
- **STAUFF Hose Connectors**
- **STAUFF Quick Release Couplings**
- **STAUFF Valves**
- **STAUFF Test**

from own, in-house development and manufacturing, the companies of the STAUFF Group provide a comprehensive range of components for fastening and connecting pipes, tubes and hoses for mobile and industrial hydraulic applications and many other industries.

The portfolio is completed by components for shutting-off, regulating, throttling and measuring fluid media.

In order to perfectly match each other, STAUFF Line products are designed and offered on a high, uniform level of quality. A large proportion of the range made from steel comes as standard with the premium STAUFF Zinc/Nickel surface coating, which is also optionally available for many of the other components.

This coating offers the most reliable surface protection far beyond the previous market standards – even after transport, handling and assembly of the components – and meets all current legal requirements.

If desired, Original Equipment Manufacturers can be supported with value-added services, from **technical consultation to pre-assembly, assembly and kitting** as well as **logistics services**:

- Support with the **selection of suitable standard components** and ordering options; provision of **customised solutions** according to customer's specifications or based on our in-house development – from prototyping to large scale production
- **Analysis and optimization** of existing and design and developments of new systems aimed at increasing the efficiency and performance of machines and equipment and creating value for customers by reducing the total cost
- **Pre-assembly, assembly and kitting** of individual components to customer-specific system modules
- Individually coordinated **procurement solutions** (e.g. web shop and electronic data interchange) and **supply models** (e.g. from warehousing of customised components to Kanban logistics and just-in-time delivery of pre-fabricated system modules to the assembly lines of the customers) aimed at optimising material flows

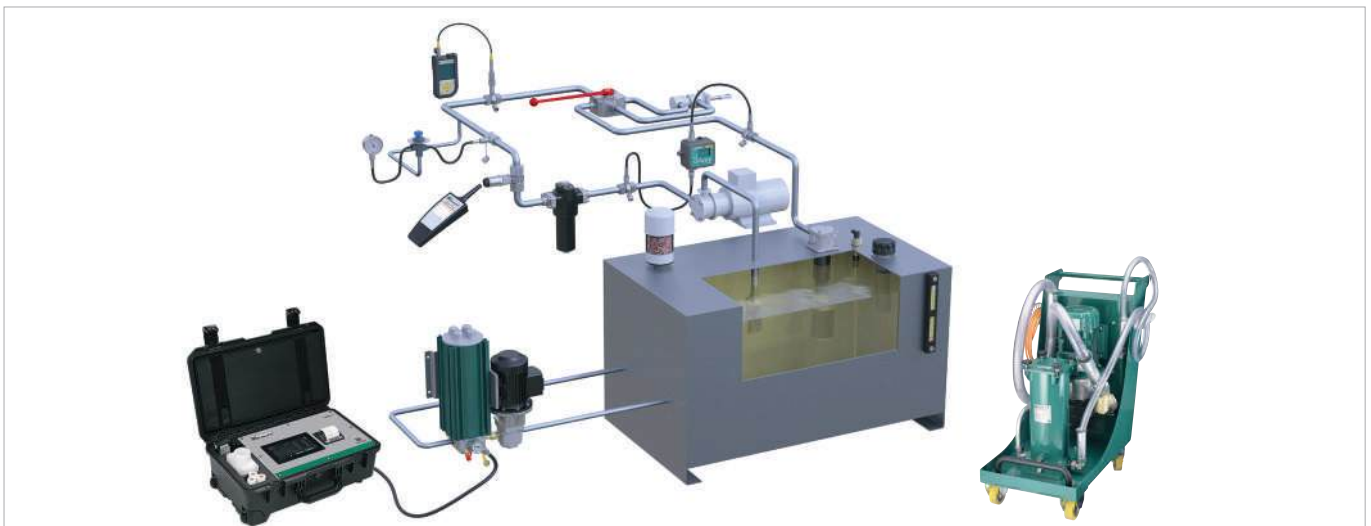

Aligned with the needs of the market, the product groups

- **STAUFF Test**
- **STAUFF Diagtronics**
- **STAUFF Filtration Technology**
- **STAUFF Hydraulic Accessories**

include a comprehensive range of analogue and digital measuring equipment and devices, filtration systems and replacement filter elements as well as accessories for the construction of tanks, reservoirs, power packs and gear boxes in mobile and industrial hydraulics.

The offer is completed by relevant value-added services:

- Support with the **selection of suitable components** and ordering options; provision of **customised solutions** according to customer's specifications or based on our in-house development – from prototyping to large scale production
- Analysis of existing hydraulic circuits aimed at filtration systems, tank components and monitoring devices that perfectly match to the specific requirements, and developing integrated concepts to increase the efficiency and performance of machines and equipment
- Individually coordinated **procurement solutions** and **supply models**



STAUFF Test

Test couplings from the STAUFF Test product range are already planned in suitable positions in the hydraulic system during the design phase of a machine, or added at a later stage in the course of retrofitting or upgrading.

They allow machine operators and maintenance personnel to easily and safely connect analogue and digital measuring and display devices for the temporary testing or continuous monitoring of system pressure and other factors.

If required, they also allow venting of the system as well as collecting representative fluid samples, e.g. for analysing the degree of contamination of the fluid.

This type of connection requires no tools and can also be carried out during operation under full system pressure up to 630 bar / 9135 PSI (depending on the type of coupling).

The check valve (ball or poppet valve) integrated into the test coupling opens only after connection of the measuring and display device with suitable adapters or test hoses, which complete the product range. This guarantees safe sealing of the connection without any risks of leakages or fluid escaping from the system.

During production, STAUFF test couplings are not crimped after insertion of the internal valve components and seals but rather closed with a threaded nipple in a fully automated process, which secures the proper functioning of the couplings under permanent loads.

The vibration protection feature, which prevents self-loosening of the protective metal cap caused by vibrations in the system, is another competitive advantage.

For the finishing of the test coupling range in carbon steel, STAUFF relies on the STAUFF Zinc/Nickel surface coating which has proven successful for many years. It provides reliable surface protection – even after transport, handling and assembly – and meets all current legal requirements.

Versions in stainless steel V2A and V4A are generally available from stock. Alternative materials and surfaces are available on request.

For selected types and series, independent certificates and approvals can be provided:

- Military approval for use as gas filling valves for nitrogen accumulators by the German Bundeswehr (Wehrtechnische Dienststelle für Pionier- und Truppengerät)
- DVGW registration as test points for gas pressure control systems, issued by the German Technical and Scientific Association for Gas and Water

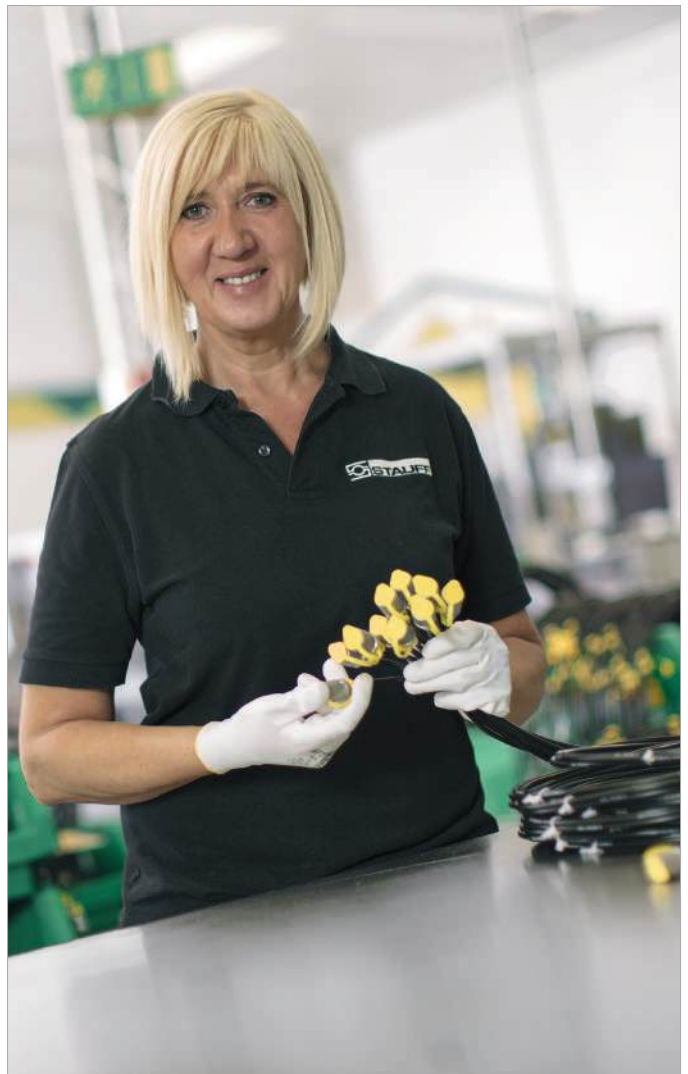

STAUFF Zinc/Nickel Coating



Layers

- Sealing
- Passivation
- Zinc/Nickel
- Steel

With at least 1200 hours resistance against red rust, the STAUFF Zinc/Nickel surface coating offers excellent surface protection – even after transport, handling and assembly. This was confirmed by testing in the salt-spray chamber according to DIN EN ISO 9227.

Users across all industries and applications benefit from sophisticated technology, which has been developed for and used by the very demanding automotive industry for many years now and that is already the proven standard for a large proportion of STAUFF components since 2007.

- At least 1200 hours resistance to red rust / base metal corrosion under practical conditions in the salt-spray chamber according to DIN EN ISO 9227
- White rust occurs only by way of a slight grey haze
- Surpassing the requirements of the corrosion protection class K5 as defined by the VDMA, the German Engineering Association (360 hours resistance to white rust / 720 hours resistance to red rust)
- Free of hexavalent chrome Cr(VI)
- ELV compliant according to 2000/53/EC (End of Life Vehicles Directive)
- REACH compliant according to 1907/2006/EC (Registration, Evaluation, Authorisation and Restriction of Chemicals)
- RoHS compliant according to 2002/95/EC (Restrictions of the Use of Hazardous Substances)
- Appealing colour scheme with a bright semi-gloss surface finish – comparable to Stainless Steel
- Significantly reduced tendency to corrosion by contact with other metals (such as Aluminium and Stainless Steel)
- Improved abrasion resistance due to the ductility / plastic deformability of the coating
- Little to no risk of triggering allergies – nickel release is down to only a fraction of the statutory limits relating to objects which come into direct and prolonged contact with the skin (independent results of the reference test method according to DIN EN 1811 are available on request)
- Good paint adhesion properties
- Resistance against all commonly used hydraulic media

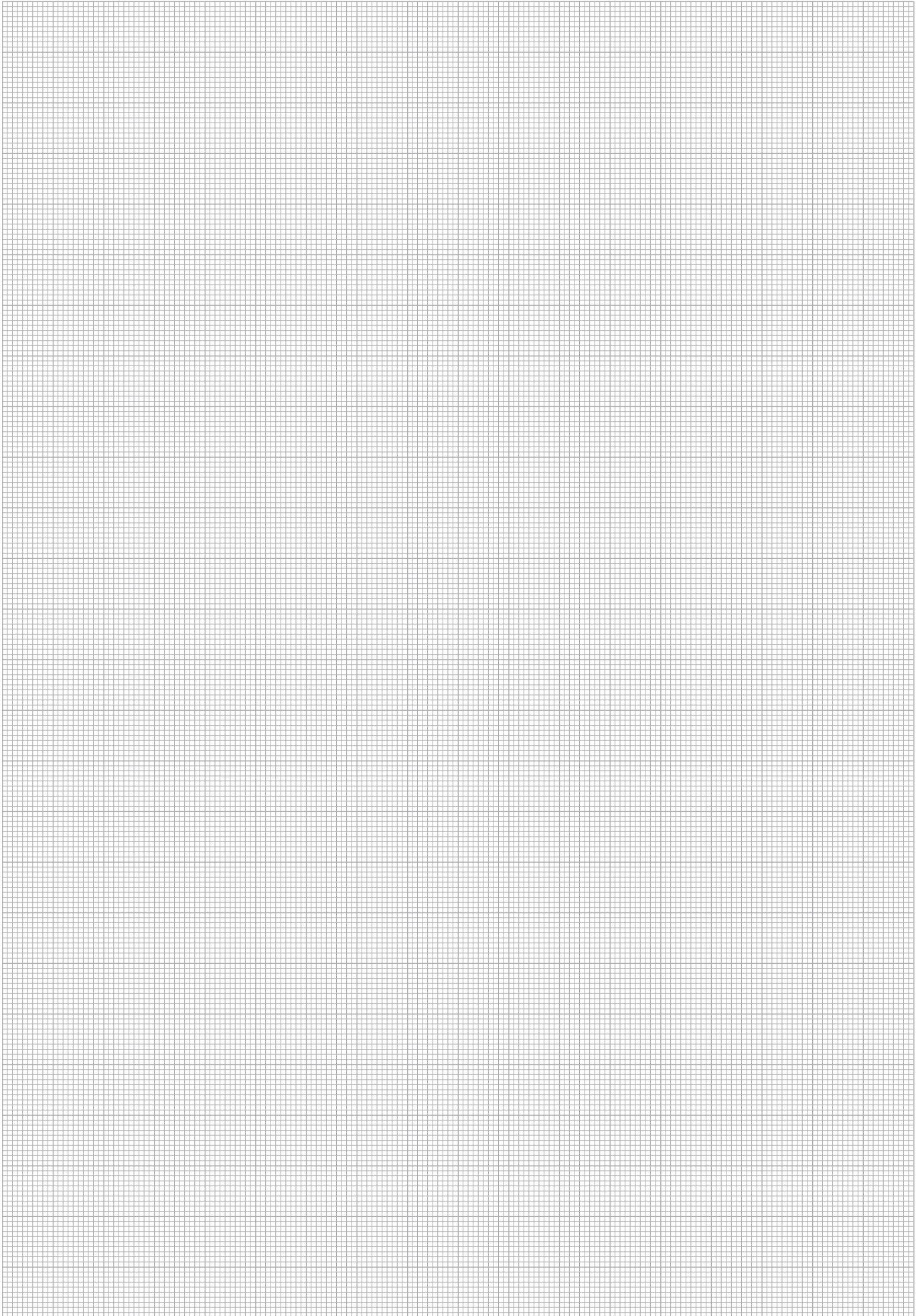



www.stauff.com





With the STAUFF Digital Platform available at www.stauff.com, commercial customers and users of STAUFF products can not only inform themselves in all detail about the 50000 components typically available from stock, but also directly purchase these online without complex registration.

General information about the companies of STAUFF Group, latest business and product news as well as complete global contact details also be available.

Main Functionalities of the STAUFF Digital Platform:

-  **Around the clock**
Check stock availability and pricing for STAUFF products in real time
-  **Cross references**
Search by article designations of other manufacturers / suppliers
-  **Live chat**
Get directly in touch with the STAUFF customer service and sales team
-  **CAD database**
Download 3D models and 2D drawings for STAUFF products

Advantages as a Registered User of the STAUFF Digital Platform:

-  **Purchase STAUFF products**
Taking customer-specific pricing and delivery conditions into account
-  **Ordering w/o searching**
Quick ordering by entering article number, quantity and requested delivery date
-  **File upload**
Direct upload of orders with multiple positions in CSV or Excel file format
-  **Notepad function**
Create project lists to save interesting products for later



www.stauff.com/cad

Immediate access to and free download of 3D models and 2D drawings for a growing number of STAUFF products

www.filterinterchange.com

Online database for the quick and easy identification and interchange of almost all common brands and types of replacement filter elements

Follow STAUFF and keep yourself updated:

-  **LinkedIn**
www.linkedin.com/company/stauff
-  **Youtube**
www.youtube.com/stauffgroup

-  **STAUFF Newsletters**
Automatic e-mail notifications about latest news from STAUFF
www.stauff.com/newsletter



Test 20 - Connection Thread M16 x 2 SMK-20 14 - 25

Introduction 14 - 15

Test Coupling with Ball Check



Test Coupling SMK-20 16

with Male Threaded Stud



Test Coupling SMK-20 Type G 17

with Straight 24° Fitting



Test Coupling SMK-20 Type K 19

With 24° Taper / O-ring (DKO)



Test Coupling SMK-20-JIC Type K 20

with 37° JIC Connection



Test Coupling SMK-20-JIC Type G 21

with Straight 37° JIC Connection



Swivel Run Tee SGV-JIC Type FM 22

with 37° JIC Connection



Test Coupling SMK-20 Type ORFS 23

with ORFS Connection



Bulkhead SSK-20 24



Test Adaptor SAD-20 24



**Gauge Adaptor SMA-20
SMD-20 25**

Test 20 - Connection Thread M16 x 2 SKK-20 26 - 31

Introduction 26 - 27

Test Coupling with Piston Valve



Test Coupling SKK-20 28

with Male Threaded Stud





















Test Coupling SKK-20 Type G 29

with Straight 24° Fitting



Test Coupling SKK-20 Type K 31

With 24° Taper / O-ring (DKO)

Test 15 - Connection Thread M16 x 1,5 SMK-15				Test 10 - Plug In System SMK-10			
	Introduction		32 - 38		Introduction		48 - 52
	Test Coupling with Ball Check				Test Coupling with Ball Check		
	Test Coupling	SMK-15	34		Test Coupling	SMK-10	50
	with Male Threaded Stud				with Male Threaded Stud		
	Test Coupling	SMK-15 Type G	35		Gauge Adaptor	SMA-10	50
	with Straight 24° Fitting						
	Test Coupling	SMK-15 Type K	36		Test Coupling	SMK-10 Type G	51
	With 24° Taper / O-ring (DKO)				with Straight 24° Fitting		
	Bulkhead	SSK-15	37		Test Coupling	SMK-10 Type K	52
					With 24° Taper / O-ring (DKO)		
	Swivel Run Tee	SGV-JIC Type FM	37		Special Test Coupling Solutions		53
	with 37° JIC Connection						
	Test Adaptor	SAD-15	38				
	Gauge Adaptor	SMA-15 SMD-15	38				
	Colour Marking Rings for Test Couplings and Test Hose Assemblies (Test 20 and Test 15)				39		
Test 12 - Connection Thread S12,65 x 1,5 SKK-12				40 - 46			
	Introduction		40 - 41				
	Test Coupling with Piston Valve						
	Test Coupling	SKK-12	42				
	with Male Threaded Stud						
	Test Coupling	SKK-12 Type G	43				
	with Straight 24° Fitting						
	Test Coupling	SKK-12 Type K	44				
	With 24° Taper / O-ring (DKO)						
	Bulkhead	SSKK-12	45				
	Swivel Run Tee	SGV-JIC Type FM	45				
	with 37° JIC Connection						
	Test Adaptor	SAD-12	46				
	Gauge Adaptor	SMA-12 SMD-12	46				

Test Coupling with Ball Check
SMK-20

A



Test Coupling with Ball Check SMK-20

A

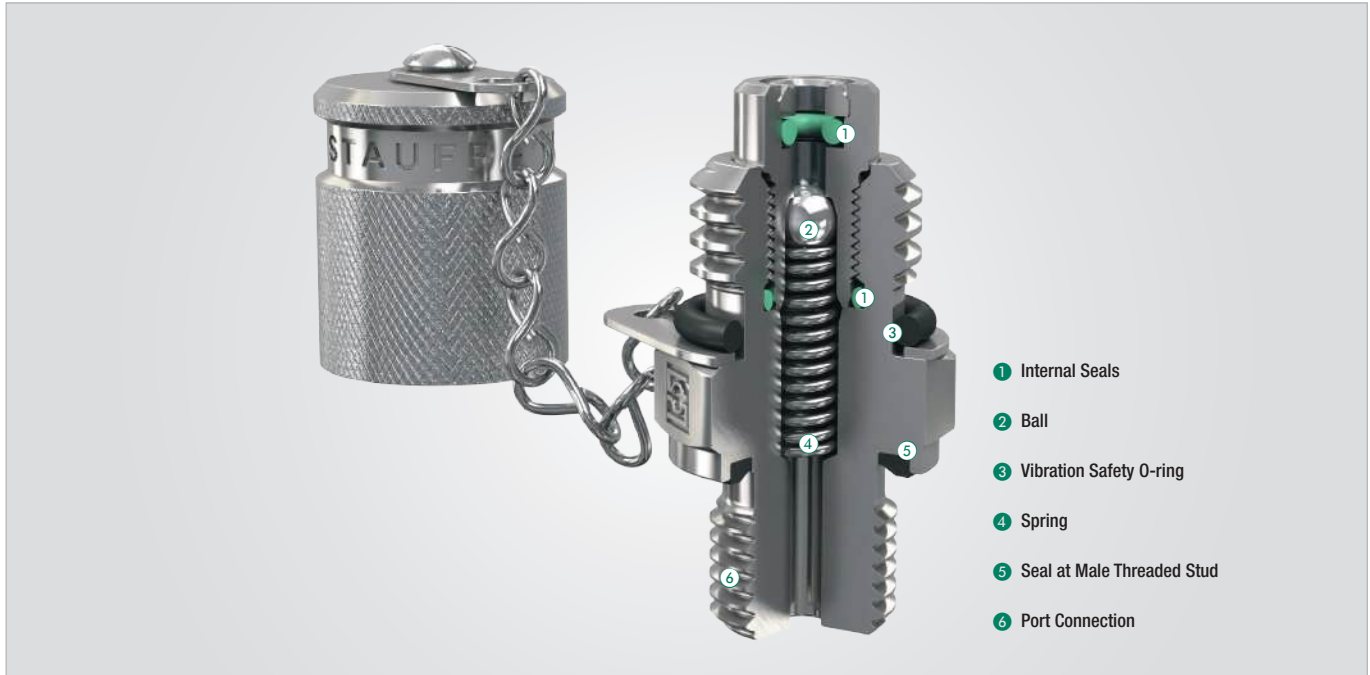

Fast Coupling for

- Monitoring and control of pressure
- Venting
- Sampling in high- and low-pressure systems
- Connection Thread according to ISO 15171-2

Advantages

- Test system at working pressure
- Leak proof connection before **Ball Check** is open
- Simple connection to measurement, control and switching devices
- Self locking metal protective cap

Working Pressure

- Max. working pressure 630 bar / 9137 PSI
For SMK Type G and K the recommended working pressure of fitting manufacturer should be noted.
- Connection under pressure up to 400 bar / 5801 PSI max.

Materials

- **Metal Parts:**
Standard material: Steel, zinc/nickel-plated = **W3**
Optional:
Stainless Steel **W4** (1.4305 / AISI 303) on request
Stainless Steel **W5** (1.4571 / AISI 316Ti) on request
- **Ball:** Stainless Steel

Seal Types:

B = NBR (Buna-N®)
(Temperature range -20 °C ... +100 °C / -4 °F ... +212 °F)
Note: Internal Seal Types made of FKM, even for standard NBR-type.

V = FKM (Viton®)*
(Temperature range -20 °C ... +200 °C / -4 °F ... +392 °F)

E = EPDM Ethylene Propylene Diene Monomer Rubber
(for Brake fluid, Temperature range -40 °C ... +150 °C / -40 °F ... +302 °F)

* Vibration safety O-ring made of NBR (Buna-N®).

Media

- Suitable for hydraulic oils and other Mineral oil based fluids
(Check compatibility of Seal Type material)
- For use with other liquid media please contact STAUFF

Protection Cap

- The complete STAUFF-Test-20-type-SMK range is also available with a hexagonal protection cap made of steel or plastic protection cap.

Colour Marking Rings

- Hydraulic test couplings and test hose assemblies of the STAUFF Test 20 and STAUFF Test 15 series made of steel and stainless steel can optionally be equipped with colour marking rings. Please see page 39 for more information.

SMK-20 Test Coupling with Male Threaded Stud and optionally colour marking ring	SMK-20 Type G Test Coupling with Straight 24° Fitting	SMK-20 Type K Test Coupling With 24° Taper / O-ring (DKO)	SMK-20-JIC Test Coupling with 37° JIC Connection	SSK-20 Bulkhead

Test Coupling with Male Threaded Stud SMK-20

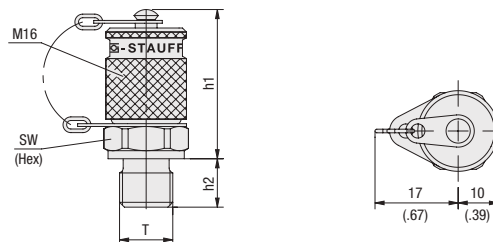

Ordering Codes

SMK-20*-G1/4*-B*-C*-SK*-W3

* Type	Test Coupling with Ball Check	SMK
* Series	STAUFF Test 20 (Connection Thread M16x2)	-20
* Port Connection	acc. to dimension table	-G1/4
* Seal Material	NBR (Buna-N®)	-B
	FKM (Viton®)	-V
	EPDM	-E
	Seal Type B and D	none
* Seal Type	O-ring Type A	-A
	Metal Joint Type B	-B
	Elastomeric Sealing Type C	-C
	Taper Type D	-D
	O-ring Type E	-E
* Protection Cap	Knurled protection cap	-
	Hexagonal protection cap	-SK
	Plastic protection cap	-KK
* Material Code	Steel, zinc/nickel-plated	-W3
	Stainless Steel V2A - 1.4305 (AISI 303)	-W4
	Stainless Steel V4A - 1.4571 (AISI 316 Ti)	-W5

Seal Type



O-ring Type A



Metal Joint Type B



Elastomeric Sealing Type C



Taper Type D¹



O-ring Type E

For further information on Seal Types,
please see page 74-77.

Thread	Seal Type	Working Pressure (^{bar} / _{PSI})	Dimensions (^{mm} / _{in})			Torque (^{Nm} / _{ft-lb}) ca.	Weight (^{kg} / _{lbs}) ca. per 100	Ordering Codes (Standard Option)
			h1	h2	Hex Thread T			
M8 x 1	Type A	250	38	8,5	17	6	6,10	SMK-20-M8x1-B-A-W3
		3625	1.50	.33	.67	4.4	13.42	
		630	38	9,8	17	12	6,70	SMK-20-M10x1-B-A-W3
M10 x 1	Type A	9137	1.50	.39	.67	8.8	14.74	
		400	37	8	17	18	6,60	SMK-20-M10x1-B-W3
M12 x 1,5	Type A	5801	1.46	.31	.67	13.3	14.52	
		630	37	12	17	35	7,00	SMK-20-M12x1.5-B-W3
M14 x 1,5	Type A	9137	1.46	.47	.67	25.8	15.40	
		630	37	12	19	55	7,50	SMK-20-M14x1.5-B-W3
M16 x 1,5	Type B	9137	1.46	.47	.75	40.6	16.50	
		630	37	12	22	70	8,40	SMK-20-M16x1.5-B-W3
G1/8	Type B	9137	1.46	.47	.87	51.6	18.48	
		400	39	8	17	18	6,90	SMK-20-G1/8-B-W3
G1/4	Type B	5801	1.54	.31	.67	13.3	15.18	
		630	37	12	19	55	7,30	SMK-20-G1/4-B-W3
G3/8	Type B	9137	1.46	.47	.75	40.6	16.06	
		630	37	12	22	90	8,90	SMK-20-G3/8-B-W3
M10 x 1	Type C	9137	1.46	.47	.87	66.4	19.58	
		400	39	8	17	18	6,80	SMK-20-M10x1-B-C-W3
M12 x 1,5	Type C	5801	1.54	.31	.67	13.3	14.96	
		630	37	12	17	35	6,90	SMK-20-M12x1.5-B-C-W3
M14 x 1,5	Type C	9137	1.46	.47	.67	25.8	15.18	
		630	37	12	19	50	7,70	SMK-20-M14x1.5-B-C-W3
M16 x 1,5	Type C	9137	1.46	.47	.75	36.9	16.94	
		630	37	12	22	60	8,70	SMK-20-M16x1.5-B-C-W3
G1/8	Type C	9137	1.46	.47	.87	44.2	19.14	
		400	39	8	17	18	6,80	SMK-20-G1/8-B-C-W3
G1/4	Type C	5801	1.54	.31	.67	13.3	14.96	
		630	37	12	19	45	8,10	SMK-20-G1/4-B-C-W3
G3/8	Type C	9137	1.46	.47	.75	33.2	17.82	
		630	37	12	22	80	8,90	SMK-20-G3/8-B-C-W3
G1/2	Type C	9137	1.46	.47	.87	59	19.58	
		630	39	14	27	110	12,80	SMK-20-G1/2-B-C-W3
R1/8 K	Type D ¹	9137	1.54	.55	1.06	81.1	28.16	
		400	37	8	17		6,70	SMK-20-R1/8K-D-W3
R1/4 K	Type D ¹	5801	1.46	.31	.67		14.74	
		630	35	12	17		7,10	SMK-20-R1/4K-D-W3
1/8 NPT	Type D ¹	9137	1.38	.47	.67		15.62	
		400	36	10	17		6,40	SMK-20-1/8NPT-D-W3
1/4 NPT	Type D ¹	5801	1.42	.39	.67		14.08	
		630	35	15	17		7,30	SMK-20-1/4NPT-D-W3
5/16-24 UNF	Type E	9137	1.38	.59	.67		16.06	
		400	38	7,5	17	8	6,70	SMK-20-5/16UNF-B-E-W3
7/16-20 UNF	Type E	5.801	1.50	.30	.67	5.9	14.74	
		630	38	9,1	17	20	7,00	SMK-20-7/16UNF-B-E-W3
1/2-20 UNF	Type E	9137	1.50	.36	.67	14.7	15.40	
		630	38	9,2	17	25	7,20	SMK-20-1/2UNF-B-E-W3
9/16-18 UNF	Type E	9137	1.50	.36	.67	18.4	15.84	
		630	37	10	19	35	7,60	SMK-20-9/16UNF-B-E-W3
3/4-16 UNF	Type E	9137	1.46	.39	.75	25.8	16.72	
		630	37	11.1	19	70	9,58	SMK-20-3/4UNF-B-E-W3
M10 x 1	Type E	9137	1.46	.44	.75	51.6	21.08	
		630	38	9,5	17	18	6,60	SMK-20-M10x1-B-E-W3
M12 x 1,5	Type E	9137	1.50	.37	.67	13.3	14.52	
		630	37	11	17	35	6,90	SMK-20-M12x1.5-B-E-W3
M14 x 1,5	Type E	9137	1.46	.43	.67	25.8	15.18	
		630	38	11	19	45	7,80	SMK-20-M14x1.5-B-E-W3
	Type E	9137	1.50	.43	.75	33.2	17.16	

¹ Suitable liquid / plastic sealant required.

Alternative materials and surface finishings are available upon request. Contact STAUFF for further information.
Torque recommendations for Steel mating material.

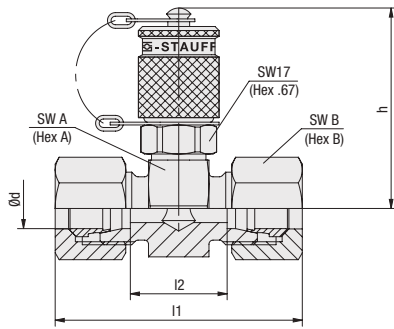
**Test Coupling with Straight 24° Fitting
SMK-20 Type G**
A

Series	PN (bar/psi)	Pipe Ød	Dimensions (mm/in)					Weight (kg/lbs) ca. per 100 ¹	Ordering Codes (Standard Option) ²
			~l1 ³	l2	h	Hex A	Hex B		
L	315 4568	6	51	21	49	24	14	14,80	SMK-20-06L-G-W3-MS
			2.01	.83	1.93	.94	.55	32.56	
		8	51	21	49	24	17	15,80	SMK-20-08L-G-W3-MS
			2.01	.83	1.93	.94	.67	34.76	
		10	53	23	49	24	19	16,70	SMK-20-10L-G-W3-MS
			2.09	.91	1.93	.94	.75	36.74	
	12	53	23	50,5	27	22	20,00	SMK-20-12L-G-W3-MS	
		2.09	.91	1.99	1.06	.87	44.00		
	15	55	25	52	30	27	26,00	SMK-20-15L-G-W3-MS	
		2.17	.98	2.05	1.18	1.06	57.20		
	18	57	24	53	32	32	32,20	SMK-20-18L-G-W3-MS	
		2.24	.94	2.09	1.26	1.26	70.84		
	160 2320	22	61	28	55	36	36	38,90	SMK-20-22L-G-W3-MS
			2.40	1.10	2.17	1.42	1.42	85.58	
		28	61	28	57,5	41	41	45,20	SMK-20-28L-G-W3-MS
			2.40	1.10	2.26	1.61	1.61	99.44	
		35	69	26	60	46	50	63,80	SMK-20-35L-G-W3-MS
			2.72	1.02	2.36	1.81	1.97	140.36	
42	71	25	64,5	55	60	88,40	SMK-20-42L-G-W3-MS		
	2.80	.98	2.54	2.17	2.36	194.48			
S	630 9137	6	55	25	49	24	17	17,10	SMK-20-06S-G-W3-MS
			2.17	.98	1.93	.94	.67	37.62	
		8	55	25	49	24	19	18,10	SMK-20-08S-G-W3-MS
			2.17	.98	1.93	.94	.75	39.82	
		10	57	24	49	24	22	20,40	SMK-20-10S-G-W3-MS
			2.24	.94	1.93	.94	.87	44.88	
	12	57	24	49	24	24	22,10	SMK-20-12S-G-W3-MS	
		2.24	.94	1.93	.94	.94	48.62		
	14	63	27	50,5	27	27	28,20	SMK-20-14S-G-W3-MS	
		2.50	1.06	1.99	1.06	1.06	62.04		
	400 5801	16	63	26	52	30	30	32,20	SMK-20-16S-G-W3-MS
			2.50	1.02	2.05	1.18	1.18	70.84	
		20	69	26	55	36	36	47,30	SMK-20-20S-G-W3-MS
			2.72	1.02	2.17	1.42	1.42	104.06	
		25	75	27	57,5	41	46	76,40	SMK-20-25S-G-W3-MS
			2.95	1.06	2.26	1.61	1.81	168.08	
	30	81	28	60	46	50	86,80	SMK-20-30S-G-W3-MS	
		3.19	1.10	2.36	1.81	1.97	190.96		
315 4568	38	91	29	64,5	55	60	127,70	SMK-20-38S-G-W3-MS	
		3.58	1.14	2.54	2.17	2.36	280.94		

Ordering Codes
***SMK*-20*-18L*-G*-SK*-W3*-MS**

* Type	Test Coupling with Ball Check	SMK
* Series	STAUFF Test 20 (Connection Thread M16x2)	-20
* Outside Tube Diameter	acc. to dimension table	-18
* Series	Light Series	L
	Heavy Series	S
* Seal Material	FKM (Viton®) EPDM	none -E
* Connection	Straight 24° Fitting	-G
* Protection Cap	Knurled protection cap	-
	Hexagonal protection cap	-SK
	Plastic protection cap	-KK
* Material Code	Steel, zinc/nickel-plated	-W3
	Stainless Steel V2A - 1.4305 (AISI 303)	-W4
	Stainless Steel V4A - 1.4571 (AISI 316 Ti)	-W5
* Assembling / Kitting	Fitting body only	-
	Fitting body supplied with Cutting rings and union nuts	-MS
	Fitting body supplied with soft-sealing cutting rings and union nuts	-MSV

¹ Weight including cutting rings and union nuts.

² Standard option: Fitting body supplied with Cutting rings and union nuts.

³ Approximate dimension in assembled condition.

Port acc. to ISO 8434-1 / DIN 2353

Alternative materials and surface finishings are available upon request. Contact STAUFF for further information.

A

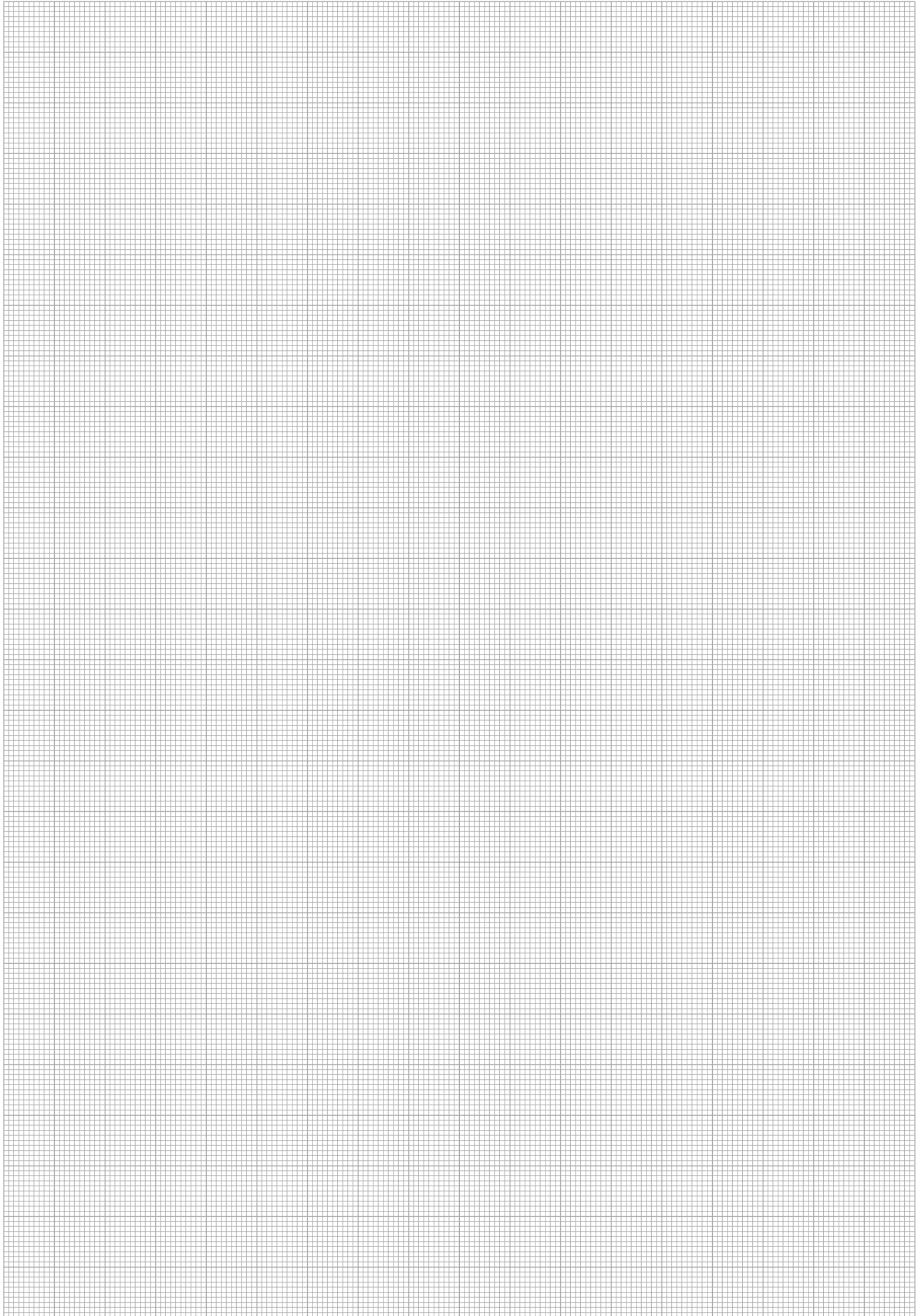

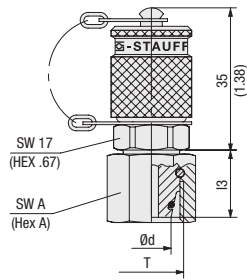
**Test Coupling with 24° Taper / O-ring (DKO)
SMK-20 Type K**
A

Version A

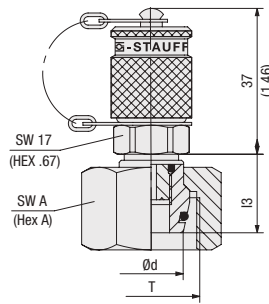

Version B



Series	PN (bar/PSI)	Pipe Ød	Dimensions (mm/in)	Thread	Version	Weight (kg/lbs) ca. per 100	Ordering Codes (Standard Option)	
			l3 Hex A T					
L	315 4568	6	15,5	14	M12 x 1,5	A	8,00	SMK-20-06L-B-K-W3
			.61	.55			17.60	
		8	15,5	17	M14 x 1,5	A	8,10	SMK-20-08L-B-K-W3
			.61	.67			17.82	
		10	16,5	19	M16 x 1,5	A	9,30	SMK-20-10L-B-K-W3
			.65	.75			20.46	
	12	17,5	22	M18 x 1,5	A	10,60	SMK-20-12L-B-K-W3	
		.69	.87			23.32		
	15	21	27	M22 x 1,5	B	12,80	SMK-20-15L-B-K-GS-W3	
		.83	1.06			28.16		
	18	19,5	32	M26 x 1,5	B	16,20	SMK-20-18L-B-K-GS-W3	
		.77	1.26			35.64		
	160 2320	22	20,5	36	M30 x 2	B	19,40	SMK-20-22L-B-K-GS-W3
			.81	1.42			42.68	
28		25	41	M36 x 2	B	25,10	SMK-20-28L-B-K-GS-W3	
		.98	1.61			55.22		
35	30	50	M45 x 2	B	40,50	SMK-20-35L-B-K-GS-W3		
	1.18	1.97			89.10			
42	31	60	M52 x 2	B	58,10	SMK-20-42L-B-K-GS-W3		
	1.22	2.36			127.82			
S	630 9137	6	14,5	17	M14 x 1,5	A	7,50	SMK-20-06S-B-K-W3
			.57	.67			16.50	
		8	16,5	19	M16 x 1,5	A	8,70	SMK-20-08S-B-K-W3
			.65	.75			19.14	
		10	16,5	22	M18 x 1,5	A	10,20	SMK-20-10S-B-K-W3
	.65		.87	22.44				
	12	17,5	24	M20 x 1,5	A	11,70	SMK-20-12S-B-K-W3	
		.69	.94			25.74		
	14	19,5	27	M22 x 1,5	B	13,10	SMK-20-14S-B-K-GS-W3	
		.77	1.06			28.82		
	400 5801	16	18	30	M24 x 1,5	B	15,40	SMK-20-16S-B-K-GS-W3
			.71	1.18			33.88	
		20	24	36	M30 x 2	B	22,00	SMK-20-20S-B-K-GS-W3
			.94	1.42			48.40	
25	26	46	M36 x 2	B	36,60	SMK-20-25S-B-K-GS-W3		
	1.02	1.81			80.52			
30	30	50	M42 x 2	B	42,70	SMK-20-30S-B-K-GS-W3		
	1.18	1.97			93.94			
315 4568	38	34	60	M52 x 2	B	63,70	SMK-20-38S-B-K-GS-W3	
		1.34	2.36			140.14		

Ordering Codes
***SMK*-20*-18L*-B*-K*-GS*-SK*-W3**

* Type	Test Coupling with Ball Check	SMK
* Series	STAUFF Test 20 (Connection Thread M16x2)	-20
* Outside Tube Diameter	acc. to dimension table	-18
* Series	Light Series	L
	Heavy Series	S
* Seal Material	NBR (Buna-N®)	-B
	FKM (Viton®)	-V
	EPDM	-E
* Connection	24° Taper / O-ring (DKO)	-K
* Design	One-piece design (Version A)	-
	Screwed design (Version B)	-GS
* Protection Cap	Knurled protection cap	-
	Hexagonal protection cap	-SK
	Plastic protection cap	-KK
* Material Code	Steel, zinc/nickel-plated	-W3
	Stainless Steel V2A - 1.4305 (AISI 303)	-W4
	Stainless Steel V4A - 1.4571 (AISI 316 Ti)	-W5

With 24° Taper / O-ring (DKO) Connection acc. to ISO 8434-1 / DIN 2353
Alternative materials and surface finishings are available upon request. Contact STAUFF for further information.

**Test Coupling with 37° JIC Connection
SMK-20-JIC Type K**

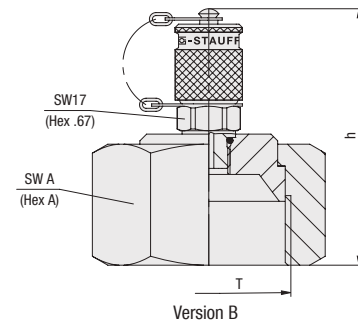
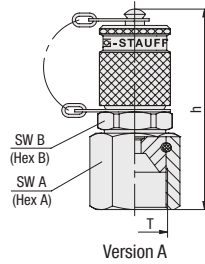

Ordering Codes

***SMK*-20*-JIC3/4*-K*-GS*-SK*-W3**

* Type	Test Coupling with Ball Check	SMK
* Series	STAUFF Test 20 (Connection Thread M16x2)	-20
* Connection	37° JIC Connection	-JIC
* Outside Tube Diameter	acc. to dimension table	3/4
* Seal Material	FKM (Viton®) EPDM	none -E
* Connection	37° JIC Taper	-K
* Design	One-piece design (Version A) Screwed design (Version B)	- -GS
* Protection Cap	Knurled protection cap Hexagonal protection cap Plastic protection cap	- -SK -KK
* Material Code	Steel, zinc/nickel-plated Stainless Steel V2A - 1.4305 (AISI 303) Stainless Steel V4A - 1.4571 (AISI 316 Ti)	-W3 -W4 -W5

Pipe Ø inch	JIC- Size	Dimensions (mm/in)			Thread	Version	Weight (#/lbs) ca. per 100	Ordering Codes (Standard Option)
		h	Hex A	Hex B				
1/4	-4	53	17	17	7/16-20 UNF	A	8,40	SMK-20-JIC1/4-K-W3
		2.09	.67	.67			18.48	
5/16	-5	53,5	17	17	1/2-20 UNF	A	8,30	SMK-20-JIC5/16-K-W3
		2.11	.67	.67			18.26	
3/8	-6	55,5	19	17	9/16-18 UNF	A	9,10	SMK-20-JIC3/8-K-W3
		2.19	.75	.67			20.02	
1/2	-8	56,5	22	19	3/4-16 UNF	A	10,40	SMK-20-JIC1/2-K-W3
		2.22	.87	.75			22.88	
5/8	-10	60	27	22	7/8-14 UNF	A	14,20	SMK-20-JIC5/8-K-W3
		2.36	1.06	.87			31.24	
3/4	-12	70,5	32	-	1-1/16-12 UN	B	17,70	SMK-20-JIC3/4-K-GS-W3
		2.78	1.26	-			38.94	
1	-16	69	38	-	1-5/16-12 UN	B	26,90	SMK-20-JIC1-K-GS-W3
		2.72	1.50	-			59.18	
1-1/4	-20	73,5	50	-	1-5/8-12 UN	B	40,20	SMK-20-JIC1-1/4-K-GS-W3
		2.89	1.97	-			88.44	
1-1/2	-24	76	60	-	1-7/8-12 UN	B	63,50	SMK-20-JIC1-1/2-K-GS-W3
		2.99	2.36	-			139.70	

With 37° JIC Connection acc. to SAE J514

Alternative materials and surface finishings are available upon request. Contact STAUFF for further information.

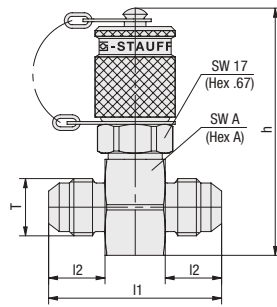
**Test Coupling with Straight 37° JIC Connection
SMK-20-JIC Type G**
A

Pipe Ø inch	JIC- Size	Dimensions (mm/in)				Thread T	Weight (*9/lbs) ca. per 100	Ordering Codes (Standard Option)
		l1	l2	h	Hex A			
1/4	-4	43	14	61	24	7/16-20 UNF	13,70	SMK-20-JIC1/4-G-W3
		1.69	.55	2.40	.94		30.14	
5/16	-5	43	14	61	24	1/2-20 UNF	12,90	SMK-20-JIC5/16-G-W3
		1.69	.55	2.40	.94		28.38	
3/8	-6	43	14	61	24	9/16-18 UNF	13,00	SMK-20-JIC3/8-G-W3
		1.69	.55	2.40	.94		28.60	
1/2	-8	48,5	16,5	67	30	3/4-16 UNF	17,90	SMK-20-JIC1/2-G-W3
		1.91	.65	2.64	1.18		39.38	
5/8	-10	53,5	19,5	67	30	7/8-14 UNF	20,70	SMK-20-JIC5/8-G-W3
		2.11	.77	2.64	1.18		45.54	
3/4	-12	59	22	73	36	1-1/16-12 UN	27,00	SMK-20-JIC3/4-G-W3
		2.32	.87	2.87	1.42		59.40	
1	-16	61	23	78	41	1-5/16-12 UN	32,60	SMK-20-JIC1-G-W3
		2.40	.91	3.07	1.61		71.72	
1-1/4	-20	65,5	24,5	83	46	1-5/8-12 UN	45,30	SMK-20-JIC1-1/4-G-W3
		2.58	.96	3.26	1.81		99.66	
1-1/2	-24	72	27,5	92	55	1-7/8-12 UN	58,30	SMK-20-JIC1-1/2-G-W3
		2.83	1.08	3.62	2.17		128.26	

With Straight 37° JIC Connection acc. to SAE J514

Alternative materials and surface finishings are available upon request. Contact STAUFF for further information.

Ordering Codes
***SMK*-20*-JIC3/4*-G*-SK*-W3**

* Type	Test Coupling with Ball Check	SMK
* Series	STAUFF Test 20 (Connection Thread M16x2)	-20
* Connection	37° JIC Connection	-JIC
* Outside Tube Diameter	acc. to dimension table	3/4
* Seal Material	FKM (Viton®) EPDM	none -E
* Connection	Straight Fitting	-G
* Protection Cap	Knurled protection cap Hexagonal protection cap Plastic protection cap	- -SK -KK
* Material Code	Steel, zinc/nickel-plated	-W3
	Stainless Steel V2A - 1.4305 (AISI 303)	-W4
	Stainless Steel V4A - 1.4571 (AISI 316 Ti)	-W5

**Swivel Run Tee with 37° JIC Connection
SGV-JIC Type FM**

A

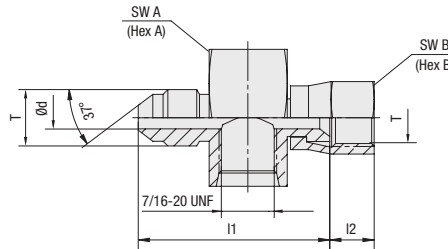

Ordering Codes

***SGV*-7/16UNF*-12*-JIC3/4*-FM*-W66**

* Type	Swivel Run Tee	SGV
* Port Connection	acc. to dimension table	-7/16UNF
* JIC Size	acc. to dimension table	-12
* Connection	37° JIC Connection	-JIC
* Outside Tube Diameter	acc. to dimension table	3/4
* Connection	Female/Male Thread	-FM
* Material Code	Carbon Steel, zinc-plated and thick-film passivated	-W66

Pipe Ø inch	JIC-Size	Dimensions (mm/in)						Thread T inch	Weight (kg/lbs) ca. per 100	Ordering Codes (Standard Option)
		Ø d	l1	l2	Hex A	Hex B				
1/4	04	4,37	37,74	8,74	27	14,29	7/16-20 UNF	8,96	SGV-7/16UNF-04-JIC1/4-FM-W66	
		.17	1.49	.34	1.06	.56		19.71		
3/8	06	7,54	40,01	9,53	27	17,46	9/16-18 UNF	9,60	SGV-7/16UNF-06-JIC3/8-FM-W66	
		.30	1.58	.38	1.06	.69		21.12		
1/2	08	9,93	44,65	10,72	27	22,23	3/4-16 UNF	11,20	SGV-7/16UNF-08-JIC1/2-FM-W66	
		.39	1.76	.42	1.06	.88		24.64		
5/8	10	12,29	48,26	12,70	28,58	25,40	7/8-14 UNF	17,10	SGV-7/16UNF-10-JIC5/8-FM-W66	
		.48	1.90	.50	1.13	1.00		37.62		
3/4	12	15,47	51,33	14,45	31,75	31,75	1-1/16-12 UN	20,40	SGV-7/16UNF-12-JIC3/4-FM-W66	
		.61	2.02	.57	1.25	1.25		44.88		
1	16	21,44	57,30	15,09	38,10	38,10	1-5/16-12 UN	30,80	SGV-7/16UNF-16-JIC1-FM-W66	
		.84	2.26	.59	1.50	1.50		67.76		

Alternative materials and surface finishings are available upon request. Contact STAUFF for further information.

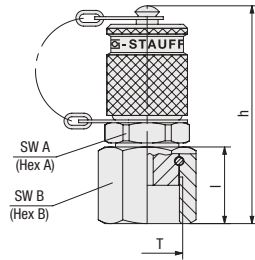
**Test Coupling with ORFS Connection
SMK-20 Type ORFS**
A

Thread T	ORFS- Size	Dimensions (^{mm} / _{in})				Weight (^{kg} / _{lbs}) ca. per 100	Ordering Codes (Standard Option)
		h	l	Hex A	Hex B		
9/16-18 UNF	04	54	19	17	19	9,50	SMK-20-04-ORFS-W3
		2.1	.75	.67	.75	20.90	
11/16-16 UN	06	54	19	19	21	9,80	SMK-20-06-ORFS-W3
		2.1	.75	.75	.80	21.60	
13/16-16 UN	08	54	19	22	24	11,69	SMK-20-08-ORFS-W3
		2.1	.75	.87	.87	25.73	

Alternative materials and surface finishings are available upon request. Contact STAUFF for further information.

Ordering Codes
***SMK*-20*-06*-ORFS*-SK*-W3**

* Type	Test Coupling with Ball Check	SMK
* Series	STAUFF Test 20 (Connection Thread M16x2)	-20
* ORFS-Size	acc. to dimension table	-06
* Connection	ORFS	-ORFS
* Seal Material	FKM (Viton®) EPDM	none -E
* Protection Cap	Knurled protection cap Hexagonal protection cap Plastic protection cap	- -SK -KK
* Material Code	Steel, zinc/nickel-plated	-W3
	Stainless Steel V2A - 1.4305 (AISI 303)	-W4
	Stainless Steel V4A - 1.4571 (AISI 316 Ti)	-W5

**Bulkhead
SSK-20**

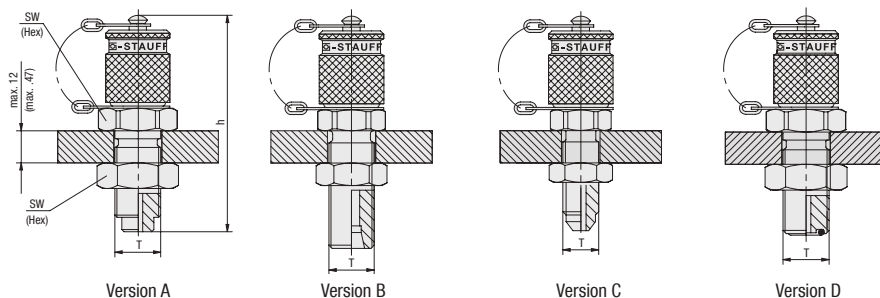

Ordering Codes

***SSK*-20*-JIC1/4*-M*-SK*-W3**

* Type	Bulkhead with Ball Check	SSK
* Series	STAUFF Test 20 (Connection Thread M16x2)	-20
* Connection	37° JIC Connection	-JIC
* Outside Tube Diameter	acc. to dimension table	1/4
* Connection	Male Thread	-M
* Seal Material	NBR (Buna-N®) FKM (Viton®) EPDM Version A/B/C	-B -V -E none
* Protection Cap	Knurled protection cap Hexagonal protection cap Plastic protection cap	- -SK -KK
* Material Code	Steel, zinc/nickel-plated Stainless Steel V2A - 1.4305 (AISI 303) Stainless Steel V4A - 1.4571 (AISI 316 Ti)	-W3 -W4 -W5

Thread	Dimensions (mm/in)		Version	Weight (kg/lbs) ca. per 100	Ordering Codes (Standard Option)
	T	h Hex			
M16 x 2	72	19	A	10,80	SSK-20-W3
	2.83	.75		23,76	
M14 x 1,5 ¹	72	19	B	10,10	SSK-20/08L-W3
	2.83	.75		22,22	
M16 x 1,5 ¹	72	22	B	12,30	SSK-20/08S-W3
	2.83	.87		27,06	
M18 x 1,5 ¹	72	24	B	11,90	SSK-20/12L-W3
	2.83	.94		26,18	
7/16-20 UNF ²	66	17	C	12,30	SSK-20-JIC1/4-M-W3
	2.60	.67		27,11	
9/16-18 UNF ³	67	22	D	12,00	SSK-20-04-ORFS-B-W3
	2.64	.87		26,40	
11/16-16 UN ³	72	27	D	16,10	SSK-20-06-ORFS-B-W3
	2.83	1.06		35,42	
13/16-16 UNF ³	75	30	D	10,00	SSK-20-08-ORFS-B-W3
	2.95	1.18		22,04	

Also available for gaseous media: Type SSKK

¹ Compression ring assembly 08L/ 08S/ 12L according to ISO 8434-1 / DIN 2353

² JIC cone fitting according to SAE J514

³ O-ring face sealing according to SAE J1453

Standard option: With Hexagon Lock Nut.

Standard option - Version B: Excluding cutting rings and union nuts

Alternative materials and surface finishings are available upon request. Contact STAUFF for further information.

**Test Adaptor
SAD-20**

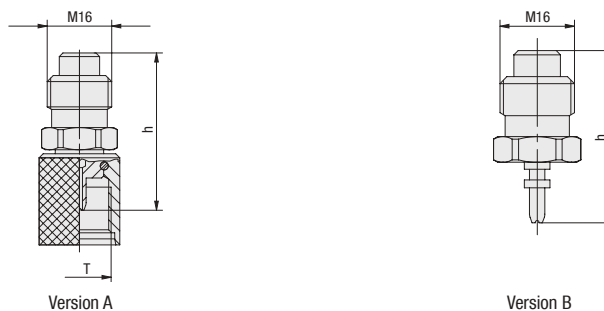

Ordering Codes

***SAD*-20/15*-W3**

* Type	Test Adaptor	SAD
* Connection Type	Version A Version A Version B	-20/15 -20/12 -20/10
* Seal Material	FKM (Viton®) EPDM	none -E
* Material Code	Steel, zinc/nickel-plated Stainless Steel V2A - 1.4305 (AISI 303) Stainless Steel V4A - 1.4571 (AISI 316 Ti)	-W3 -W4 -W5

Thread	Dimensions (mm/in)		Version	Weight (kg/lbs) ca. per 100	Ordering Codes (Standard Option)
	T	h			
M16 x 1,5	39	1.54	A	5,80	SAD-20/15-W3
	39	1.54		12,76	
S12 ¹	39	1.54	A	5,30	SAD-20/12-W3
	37	1.46		11,66	
Plug in	37	1.46	B	3,40	SAD-20/10-W3
	37	1.46		7,48	

¹ Special thread: buttress thread S12,65 x1,5

Alternative materials and surface finishings are available upon request. Contact STAUFF for further information.

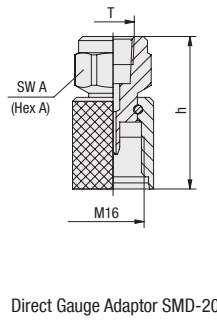
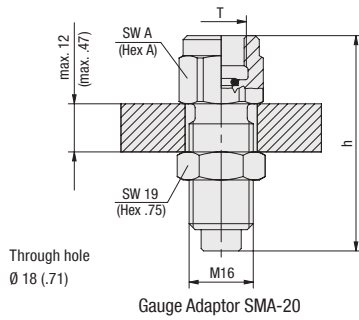
**Gauge Adaptor
SMA-20**
**Direct Gauge Adaptor
SMD-20**

A

Thread T	Dimensions (mm/in)		Weight (^{kg} /lbs) ca. per 100	Ordering Codes (Standard Option)
	h	Hex A		
G1/4	54	19	7,20	SMA-20-G1/4-B-OR-W3
	2.13	.75	15.84	
G1/2	64	27	12,40	SMA-20-G1/2-B-OR-W3
	2.52	1.06	27.28	
1/4 NPT	54	19	7,20	SMA-20-1/4NPT-W3
	2.13	.75	15.84	
1/2 NPT	64	27	13,50	SMA-20-1/2NPT-W3
	2.52	1.06	29.70	
7/16-20 UNF	54	19	7,60	SMA-20-7/16UNF-W3
	2.16	.75	16.76	
9/16-18 UNF	57	19	7,50	SMA-20-9/16UNF-W3
	2.24	.75	16.53	
G1/4	41	19	5,70	SMD-20-G1/4-B-OR-W3
	1.61	.75	12.54	
G1/2	51	27	10,10	SMD-20-G1/2-B-OR-W3
	2.01	1.06	22.22	
1/4 NPT	41	19	5,80	SMD-20-1/4NPT-W3
	1.61	.75	12.76	
1/2 NPT	51	27	10,80	SMD-20-1/2NPT-W3
	2.01	1.06	23.76	
7/16-20 UNF	41	19	6,00	SMD-20-7/16UNF-W3
	1.61	.75	13.20	
9/16-18 UNF	43	19	5,25	SMD-20-9/16UNF-W3
	1.69	.75	11.55	

Ordering Codes
***SMA*-20*-G1/4*-B*-OR*-W3**

* Type	Gauge Adaptor	SMA
* Series	STAUFF Test 20 (Connection Thread M16x2)	-20
* Thread	acc. to dimension table	-G1/4
* Seal Material	NBR (Buna-N®) FKM (Viton®) EPDM	-B -V -E
	Seal Type without O-ring	none
* Seal Type	with O-ring	-OR
* Material Code	Steel, zinc/nickel-plated Stainless Steel V2A - 1.4305 (AISI 303) Stainless Steel V4A - 1.4571 (AISI 316 Ti)	-W3 -W4 -W5

Standard option - SMA-20: With Hexagon Lock Nut.

Alternative materials and surface finishings are available upon request. Contact STAUFF for further information.
Snubber on request.

Test Coupling with Piston Valve
SKK-20

A



Test Coupling with Piston Valve SKK-20

A

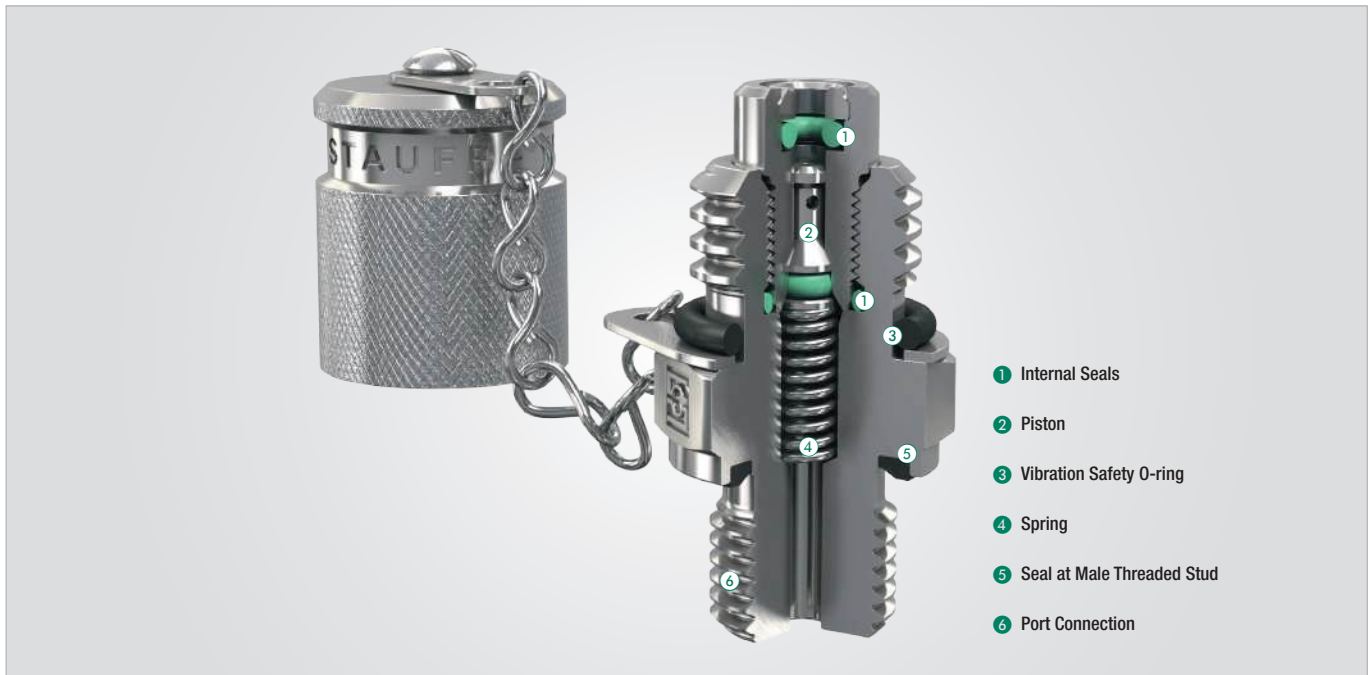

- 1 Internal Seals
- 2 Piston
- 3 Vibration Safety O-ring
- 4 Spring
- 5 Seal at Male Threaded Stud
- 6 Port Connection

Fast Coupling for

- Monitoring and control of pressure
- Venting
- Sampling in high- and low-pressure systems
- Filling of accumulators (special filling-version)
- Connection Thread according to ISO 15171-2

Advantages

- Test system at working pressure
- Leakproof connection before **piston valve** is open
- Simple connection to measurement, control and switching devices
- Self locking metal protective cap

Working Pressure

- Max. working pressure 630 bar / 9137 PSI
For SKK Type G and K the recommended working pressure of fitting manufacturer should be noted.
- Connection under pressure up to 400 bar / 5801 PSI max.

DVGW

- DVGW registration as test points for gas pressure controlsystems, issued by the German Technical and Scientific Association for Gas and Water
- The DVGW approval relates solely to the SKK-12 and SKK-20 series with connection types:
 - M8x1-V-A-DVGW
 - M10x1-V-A-DVGW
 - 1/8NPT-V-D-DVGW
 - 1/4NPT-V-D-DVGW

Protection Cap

- The complete STAUFF-Test-20-Type-SKK range is also available with a hexagonal protection cap made of steel or plastic protection cap.

Media

- Suitable for hydraulic oils and other Mineral oil based fluids (Check compatibility of sealing material)
- For use with other liquid media please contact STAUFF
- In case of ultimate tightness requirements for gaseous media, a special Gas-type is available

Materials

- **Metal Parts:**
Standard material: Steel, zinc/nickel-plated = **W3**
Optional:
Stainless Steel **W4** (1.4305 / AISI 303) on request
Stainless Steel **W5** (1.4571 / AISI 316Ti) on request

- **Seal Types:**
B = NBR (Buna-N®)
(Temperature range -20 °C ... +100 °C / -4 °F ... +212 °F)
Note: Internal sealings made of FKM, even for standard NBR-type.

V = FKM (Viton®)*
(Temperature range -20 °C ... +200 °C / -4 °F ... +392 °F)

E = EPDM Ethylene Propylene Diene Monomer Rubber
(for Brake fluid, Temperature range -40 °C ... +150 °C / -40 °F ... +302 °F)

* Vibration safety O-ring made of NBR (Buna-N®).

Colour Marking Rings

- Hydraulic test couplings and test hose assemblies of the STAUFF Test 20 and STAUFF Test 15 series made of steel and stainless steel can optionally be equipped with colour marking rings. Please see page 39 for more information.

SKK-20 Test Coupling with Male Threaded Stud and optionally colour marking ring	SKK-20 Type G Test Coupling with Straight 24° Fitting	SKK-20 Type K Test Coupling With 24° Taper / O-ring (DKO)
		

Test Coupling with Male Threaded Stud SKK-20

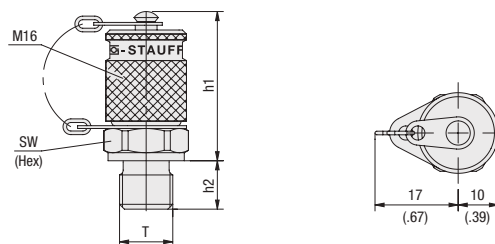

Ordering Codes

SKK-20*-G1/4*-B*-C*-SK*-W3

* Type	Test Coupling with Piston Valve	SKK
* Series	STAUFF Test 20 (Connection Thread M16x2)	-20
* Port Connection	acc. to dimension table	-G1/4
* Seal Material	NBR (Buna-N®)	-B
	FKM (Viton®)	-V
	EPDM	-E
	Seal Type B and D	none
* Seal Type	O-ring Type A	-A
	Metal Joint Type B	-B
	Elastomeric Sealing Type C	-C
	Taper Type D	-D
	O-ring Type E	-E
* Protection Cap	Knurled protection cap	-
	Hexagonal protection cap	-SK
	Plastic protection cap	-KK
* Material Code	Steel, zinc/nickel-plated	-W3
	Stainless Steel V2A - 1.4305 (AISI 303)	-W4
	Stainless Steel V4A - 1.4571 (AISI 316 Ti)	-W5

Seal Type



O-ring Type A



Metal Joint Type B



Elastomeric Sealing Type C



Taper Type D¹



O-ring Type E

Thread	Seal Type	Working Pressure (bar/PSI)	Dimensions (mm/in)			Torque (Nm/lb-ft) ca.	Weight (kg/lbs) ca. per 100	Ordering Codes (Standard Option)
			h1	h2	Hex Thread T			
M8 x 1	Type A	250	38	8,5	17	6	6,40	SKK-20-M8x1-B-A-W3
		3625	1.50	.33	.67	4.4	14.08	
		630	38	9,8	17	12	6,90	SKK-20-M10x1-B-A-W3
M10 x 1	Type A	9137	1.50	.39	.67	8.8	15.18	
		630	37	12	17	35	7,50	SKK-20-M12x1.5-B-W3
M12 x 1,5	Type A	9137	1.46	.47	.67	25.8	16.50	
		630	37	12	19	55	7,70	SKK-20-M14x1.5-B-W3
M14 x 1,5	Type A	9137	1.46	.47	.75	40.6	16.94	
		630	37	12	22	70	8,80	SKK-20-M16x1.5-B-W3
M16 x 1,5	Type B	9137	1.46	.47	.87	51.6	19.36	
		630	37	12	19	55	7,60	SKK-20-G1/4-B-W3
G1/4	Type B	9137	1.46	.47	.75	40.6	16.72	
		630	37	12	22	90	9,10	SKK-20-G3/8-B-W3
G3/8	Type B	9137	1.46	.47	.87	66.4	20.02	
		400	39	8	17	18	7,10	SKK-20-M10x1-B-C-W3
M10 x 1	Type C	5801	1.54	.31	.67	13.3	15.62	
		630	37	12	17	35	6,90	SKK-20-M12x1.5-B-C-W3
M12 x 1,5	Type C	9137	1.46	.47	.67	25.8	15.18	
		630	37	12	19	50	7,70	SKK-20-M14x1.5-B-C-W3
M14 x 1,5	Type C	9137	1.46	.47	.75	36.9	16.94	
		630	37	12	22	60	8,80	SKK-20-M16x1.5-B-C-W3
M16 x 1,5	Type C	9137	1.46	.47	.87	44.2	19.36	
		400	39	8	17	18	7,00	SKK-20-G1/8-B-C-W3
G1/8	Type C	5801	1.54	.31	.67	13.3	15.40	
		630	37	12	19	45	7,80	SKK-20-G1/4-B-C-W3
G1/4	Type C	9137	1.46	.47	.75	33.2	17.16	
		630	37	12	22	80	9,20	SKK-20-G3/8-B-C-W3
G3/8	Type C	9137	1.46	.47	.87	59	20.24	
		630	39	14	27	110	12,70	SKK-20-G1/2-B-C-W3
G1/2	Type C	9137	1.54	.55	1.06	81.1	27.94	
		400	37	8	17		6,60	SKK-20-R1/8K-D-W3
R1/8 K	Type D ¹	5801	1.46	.31	.67		14.52	
		630	35	12	17		7,20	SKK-20-R1/4K-D-W3
R1/4 K	Type D ¹	9137	1.38	.47	.67		15.84	
		400	36	10	17		6,30	SKK-20-1/8NPT-D-W3
1/8 NPT	Type D ¹	5801	1.42	.39	.67		13.86	
		630	35	15	17		7,10	SKK-20-1/4NPT-D-W3
1/4 NPT	Type D ¹	9137	1.38	.59	.67		15.62	
		400	38	7,5	17	8	6,60	SKK-20-5/16UNF-B-E-W3
5/16-24 UNF	Type E	5801	1.50	.30	.67	5.9	14.52	
		630	38	9,1	17	20	7,30	SKK-20-7/16UNF-B-E-W3
7/16-20 UNF	Type E	9137	1.50	.36	.67	14.7	16.06	
		630	38	9,2	17	25	7,10	SKK-20-1/2UNF-B-E-W3
1/2-20 UNF	Type E	9137	1.50	.36	.67	18.4	15.62	
		630	37	10	19	35	7,80	SKK-20-9/16UNF-B-E-W3
9/16-18 UNF	Type E	9137	1.46	.39	.75	25.8	17.16	
		630	37	11	17	35	6,90	SKK-20-M12x1.5-B-E-W3
M12 x 1,5	Type E	9137	1.46	.43	.67	25.8	15.21	
		630	38	11	19	45	7,60	SKK-20-M14x1.5-B-E-W3
M14 x 1,5	Type E	9137	1.50	.43	.75	33.2	16.72	

¹ Suitable liquid / plastic sealant required.

Alternative materials and surface finishings are available upon request. Contact STAUFF for further information.
Torque recommendations for Steel mating material.

For further information on Seal Types, please see page 74-77.

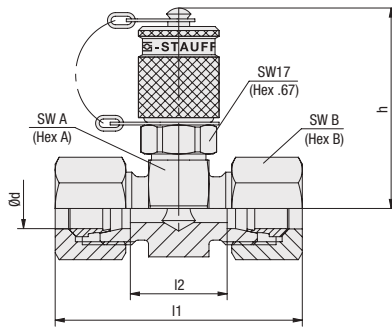
**Test Coupling with Straight 24° Fitting
SKK-20 Type G**
A

Series	PN (bar/PSI)	Pipe Ød	Dimensions (mm/in)					Weight (kg/lbs) ca. per 100 ¹	Ordering Codes (Standard Option) ²	
			~l1 ³	l2	h	Hex A	Hex B			
L	315 4568	6	51	21	49	24	14	14,70	SKK-20-06L-G-W3-MS	
			2.01	.83	1.93	.94	.55	32,34		
		8	51	21	49	24	17	15,90	SKK-20-08L-G-W3-MS	
			2.01	.83	1.93	.94	.67	34,98		
		10	53	23	49	24	19	17,00	SKK-20-10L-G-W3-MS	
			2.09	.91	1.93	.94	.75	37,40		
		12	53	23	50,5	27	22	19,80	SKK-20-12L-G-W3-MS	
			2.09	.91	1.99	1.06	.87	43,56		
		15	55	25	52	30	27	25,90	SKK-20-15L-G-W3-MS	
			2.17	.98	2.05	1.18	1.06	56,98		
		18	57	24	53	32	32	32,00	SKK-20-18L-G-W3-MS	
			2.24	.94	2.09	1.26	1.26	70,40		
	160 2320	22	61	28	55	36	36	38,90	SKK-20-22L-G-W3-MS	
			2.40	1.10	2.17	1.42	1.42	85,58		
		28	61	28	57,5	41	41	45,00	SKK-20-28L-G-W3-MS	
			2.40	1.10	2.26	1.61	1.61	99,00		
		35	69	26	60	46	50	63,80	SKK-20-35L-G-W3-MS	
			2.72	1.02	2.36	1.81	1.97	140,36		
42	71	25	64,5	55	60	88,30	SKK-20-42L-G-W3-MS			
	2.80	.98	2.54	2.17	2.36	194,26				
S	630 9137	6	55	25	49	24	17	17,10	SKK-20-06S-G-W3-MS	
			2.17	.98	1.93	.94	.67	37,62		
		8	55	25	49	24	19	18,10	SKK-20-08S-G-W3-MS	
			2.17	.98	1.93	.94	.75	39,82		
		10	57	24	49	24	22	21,10	SKK-20-10S-G-W3-MS	
			2.24	.94	1.93	.94	.87	46,42		
		12	57	24	49	24	24	22,00	SKK-20-12S-G-W3-MS	
			2.24	.94	1.93	.94	.94	48,40		
		14	63	27	50,5	27	27	28,20	SKK-20-14S-G-W3-MS	
			2.50	1.06	1.99	1.06	1.06	62,17		
		400 5801	16	63	26	52	30	30	32,60	SKK-20-16S-G-W3-MS
				2.50	1.02	2.05	1.18	1.18	71,72	
	20		69	26	55	36	36	47,30	SKK-20-20S-G-W3-MS	
			2.72	1.02	2.17	1.42	1.42	104,06		
	25		75	27	57,5	41	46	74,00	SKK-20-25S-G-W3-MS	
			2.95	1.06	2.26	1.61	1.81	162,80		
	30	81	28	60	46	50	87,70	SKK-20-30S-G-W3-MS		
		3.19	1.10	2.36	1.81	1.97	192,94			
315 4568	38	91	29	64,5	55	60	128,10	SKK-20-38S-G-W3-MS		
		3.58	1.14	2.54	2.17	2.36	281,82			

Ordering Codes
***SKK*-20*-18L*-G*-SK*-W3*-MS**

* Type	Test Coupling with Piston Valve	SKK
* Series	STAUFF Test 20 (Connection Thread M16x2)	-20
* Outside Tube Diameter	acc. to dimension table	-18
* Series	Light Series	L
	Heavy Series	S
* Seal Material	FKM (Viton®) EPDM	none -E
* Connection	Straight 24° Fitting	-G
* Protection Cap	Knurled protection cap	-
	Hexagonal protection cap	-SK
	Plastic protection cap	-KK
* Material Code	Steel, zinc/nickel-plated	-W3
	Stainless Steel V2A - 1.4305 (AISI 303)	-W4
	Stainless Steel V4A - 1.4571 (AISI 316 Ti)	-W5
* Assembling / Kitting	Fitting body only	-
	Fitting body supplied with Cutting rings and union nuts	-MS
	Fitting body supplied with soft-sealing cutting rings and union nuts	-MSV

¹ Weight including cutting rings and union nuts.

² Standard option: Fitting body supplied with Cutting rings and union nuts.

³ Approximate dimension in assembled condition.

Port acc. to ISO 8434-1 / DIN 2353

Alternative materials and surface finishings are available upon request. Contact STAUFF for further information.

A

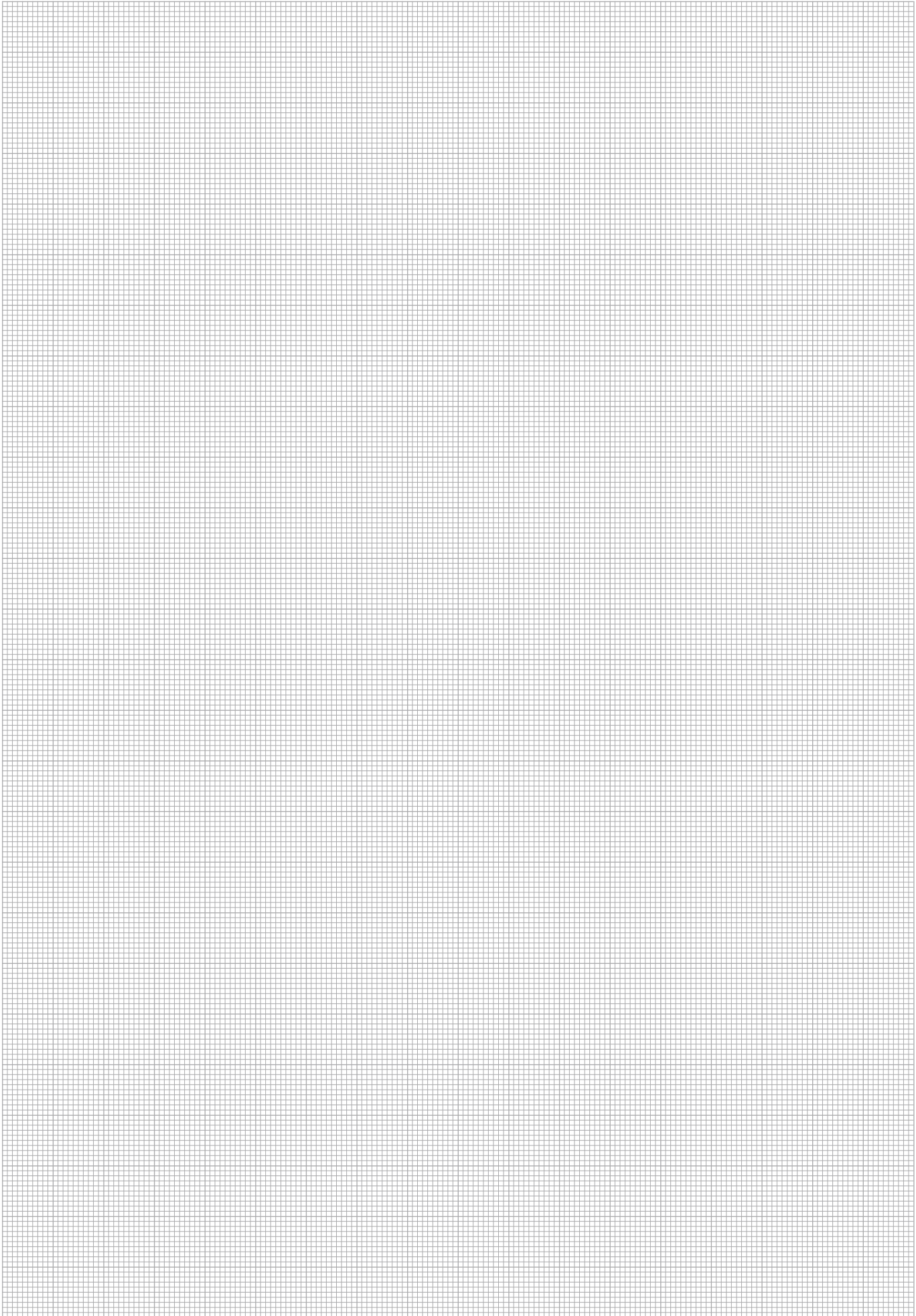

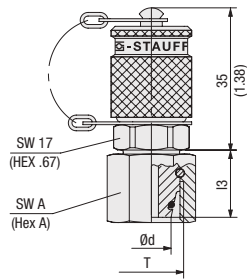
**Test Coupling with 24° Taper / O-ring (DKO)
SKK-20 Type K**
A

Version A

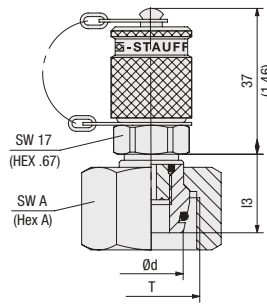

Version B



Series	PN (^{bar} / _{PSI})	Pipe Ød	Dimensions (^{mm} / _{in})		Thread	Version	Weight (^{kg} / _{lbs}) ca. per 100	Ordering Codes (Standard Option)
			l3	Hex A				
L	315 4568	6	15,5	14	M12 x 1,5	A	8,10	SKK-20-06L-B-K-W3
			.61	.55			17.82	
		8	15,5	17	M14 x 1,5	A	7,80	SKK-20-08L-B-K-W3
			.61	.67			17.16	
		10	16,5	19	M16 x 1,5	A	9,20	SKK-20-10L-B-K-W3
			.65	.75			20.24	
	12	17,5	22	M18 x 1,5	A	10,50	SKK-20-12L-B-K-W3	
		.69	.87			23.10		
	15	21	27	M22 x 1,5	B	13,10	SKK-20-15L-B-K-GS-W3	
		.83	1.06			28.82		
	18	19,5	32	M26 x 1,5	B	16,40	SKK-20-18L-B-K-GS-W3	
		.77	1.26			36.08		
	160 2320	22	20,5	36	M30 x 2	B	20,00	SKK-20-22L-B-K-GS-W3
			.81	1.42			44.00	
28		25	41	M36 x 2	B	26,50	SKK-20-28L-B-K-GS-W3	
		.98	1.61			58.30		
35		30	50	M45 x 2	B	46,20	SKK-20-35L-B-K-GS-W3	
	1.18	1.97	101.64					
42	31	60	M52 x 2	B	58,90	SKK-20-42L-B-K-GS-W3		
	1.22	2.36			129.58			
S	630 9137	6	14,5	17	M14 x 1,5	A	8,00	SKK-20-06S-B-K-W3
			.57	.67			17.60	
		8	16,5	19	M16 x 1,5	A	8,80	SKK-20-08S-B-K-W3
			.65	.75			19.36	
		10	16,5	22	M18 x 1,5	A	10,30	SKK-20-10S-B-K-W3
	.65		.87	22.66				
	12	17,5	24	M20 x 1,5	A	12,00	SKK-20-12S-B-K-W3	
		.69	.94			26.40		
	14	19,5	27	M22 x 1,5	B	13,20	SKK-20-14S-B-K-GS-W3	
		.77	1.06			29.04		
	400 5801	16	18	30	M24 x 1,5	B	15,40	SKK-20-16S-B-K-GS-W3
			.71	1.18			33.88	
		20	24	36	M30 x 2	B	22,10	SKK-20-20S-B-K-GS-W3
			.94	1.42			48.62	
25		26	46	M36 x 2	B	36,20	SKK-20-25S-B-K-GS-W3	
	1.02	1.81	79.64					
30	30	50	M42 x 2	B	43,20	SKK-20-30S-B-K-GS-W3		
	1.18	1.97			95.04			
315 4568	38	34	60	M52 x 2	B	64,60	SKK-20-38S-B-K-GS-W3	
	1.34	2.36	142.12					

Ordering Codes
***SKK*-20*-18L*-B*-K*-GS*-SK*-W3**

* Type	Test Coupling with Piston Valve	SKK
* Series	STAUFF Test 20 (Connection Thread M16x2)	-20
* Outside Tube Diameter	acc. to dimension table	-18
* Series	Light Series	L
	Heavy Series	S
* Seal Material	NBR (Buna-N®)	-B
	FKM (Viton®)	-V
	EPDM	-E
* Connection	24° Taper / O-ring (DKO)	-K
* Design	One-piece design (Version A)	-
	Screwed design (Version B)	-GS
* Protection Cap	Knurled protection cap	-
	Hexagonal protection cap	-SK
	Plastic protection cap	-KK
* Material Code	Steel, zinc/nickel-plated	-W3
	Stainless Steel V2A - 1.4305 (AISI 303)	-W4
	Stainless Steel V4A - 1.4571 (AISI 316 Ti)	-W5

With 24° Taper / O-ring (DKO) Connection acc. to ISO 8434-1 / DIN 2353
Alternative materials and surface finishings are available upon request. Contact STAUFF for further information.

Test Coupling with Ball Check
SMK-15

A



Test Coupling with Ball Check SMK-15

A



Fast Coupling for

- Monitoring and control of pressure
- Venting
- Sampling in high- and low-pressure systems

Advantages

- Test system at working pressure
- Leak proof connection before **Ball Check** is open
- Simple connection to measurement, control and switching devices
- Self locking metal protective cap

Working Pressure

- Max. working pressure 630 bar / 9137 PSI
For SMK Type G and K the recommended working pressure of fitting manufacturer should be noted.
- Connection under pressure up to 630 bar / 9137 PSI max.

Materials

- **Metal Parts:**
Standard Material Code: Steel, zinc/nickel-plated, black = **W3**
Optional:
Stainless Steel **W4** (1.4305 / AISI 303) on request
Stainless Steel **W5** (1.4571 / AISI 316Ti) on request

- **Ball:** Stainless Steel

- **Seal Types:**
B = NBR (Buna-N®)
(Temperature range -20 °C ... +100 °C / -4 °F ... +212 °F)
Note: Internal sealings made of FKM, even for standard NBR-type.

V = FKM (Viton®)*
(Temperature range -20 °C ... +200 °C / -4 °F ... +392 °F)

E = EPDM Ethylene Propylene Diene Monomer Rubber
(for Brake fluid, Temperature range -40 °C ... +150 °C / -40 °F ... +302 °F)

* Vibration safety O-ring made of NBR (Buna-N®).

Media

- Suitable for hydraulic oils and other Mineral oil based fluid (Check compatibility of seal material)
- For use with other liquid media please contact STAUFF

Protection Cap





- The complete STAUFF-Test-15-Type-SMK range is also available with a hexagonal protection cap made of steel.

Colour Marking Rings

- Hydraulic test couplings and test hose assemblies of the STAUFF Test 20 and STAUFF Test 15 series made of steel and stainless steel can optionally be equipped with colour marking rings. Please see page 39 for more information.

Note

- On request TEST 15 is also available as SKK-type including "Gas"- and "Filling"-versions.

SMK-15 Test Coupling with Male Threaded Stud and optionally colour marking ring	SMK-15 Type G Test Coupling with Straight 24° Fitting	SMK-15 Type K Test Coupling With 24° Taper / O-ring (DKO)	SSK-15 Bulkhead
			

Test Coupling with Male Threaded Stud SMK-15

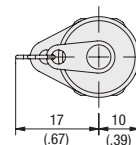
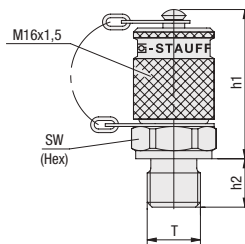

Ordering Codes

SMK-15*-G1/4*-B*-C*-SK*-W3

* Type	Test Coupling with Ball Check	SMK
* Series	STAUFF Test 15 (Connection Thread M16x1,5)	-15
* Port Connection	acc. to dimension table	-G1/4
* Seal Material	NBR (Buna-N®)	-B
	FKM (Viton®)	-V
	EPDM	-E
	Seal Type B and D	none
* Seal Type	O-ring Type A	-A
	Metal Joint Type B	-B
	Elastomeric Sealing Type C	-C
	Taper Type D	-D
	O-ring Type E	-E
* Protection Cap	Knurled protection cap	-
	Hexagonal protection cap	-SK
* Material Code	Steel, zinc/nickel-plated	-W3
	Stainless Steel V2A - 1.4305 (AISI 303)	-W4
	Stainless Steel V4A - 1.4571 (AISI 316 Ti)	-W5

Seal Type



O-ring Type A



Metal Joint Type B



Elastomeric Sealing Type C



Taper Type D¹



O-ring Type E

Thread	Seal Type	Working Pressure (bar/psi)	Dimensions (mm/in)			Torque (Nm/lb-ft) ca.	Weight (kg/lbs) ca. per 100	Ordering Codes (Standard Option)
			h1	h2	Hex Thread T			
M10 x 1	Type A	630	38	9,8	17	12	6,90	SMK-15-M10x1-B-A-W3
		9137	1.50	.39	.67	8,8	15,18	
M14 x 1,5		630	37	12	19	55	7,90	SMK-15-M14x1.5-B-W3
		9137	1.46	.47	.75	40,6	17,38	
M16 x 1,5		630	37	12	22	70	8,80	SMK-15-M16x1.5-B-W3
		9137	1.46	.47	.87	51,6	19,36	
G1/8	Type B	400	39	8	17	18	6,90	SMK-15-G1/8-B-W3
		5801	1.54	.31	.67	13,3	15,21	
G1/4		630	37	12	19	55	7,60	SMK-15-G1/4-B-W3
		9137	1.46	.47	.75	40,6	16,72	
G3/8		630	37	12	22	90	9,00	SMK-15-G3/8-B-W3
		9137	1.46	.47	.87	66,4	19,80	
M12 x 1,5		630	37	12	17	35	7,10	SMK-15-M12x1.5-B-C-W3
		9137	1.46	.47	.67	25,8	15,62	
M14 x 1,5		630	37	12	19	50	7,70	SMK-15-M14x1.5-B-C-W3
		9137	1.46	.47	.75	36,9	16,94	
M16 x 1,5	Type C	630	37	12	22	60	8,50	SMK-15-M16x1.5-B-C-W3
		9137	1.46	.47	.87	44,2	18,70	
G1/8		400	39	8	17	18	6,60	SMK-15-G1/8-B-C-W3
		5801	1.54	.31	.67	13,3	14,52	
G1/4		630	37	12	19	45	7,60	SMK-15-G1/4-B-C-W3
		9137	1.46	.47	.75	33,2	16,72	
R1/4 K		630	35	12	17		7,10	SMK-15-R1/4K-D-W3
		9137	1.38	.47	.67		15,62	
1/8 NPT	Type D ¹	400	36	10	17		6,50	SMK-15-1/8NPT-D-W3
		5801	1.42	.39	.67		14,30	
1/4 NPT		630	35	15	17		7,20	SMK-15-1/4NPT-D-W3
		9137	1.38	.59	.67		15,84	
7/16-20 UNF		630	38	9,1	17	20	7,00	SMK-15-7/16UNF-B-E-W3
		9137	1.50	.36	.67	14,7	15,40	
9/16-18 UNF	Type E	630	37	10	19	35	7,60	SMK-15-9/16UNF-B-E-W3
		9137	1.46	.39	.75	25,5	16,72	
M14 x 1,5		630	38	11	19	45	7,80	SMK-15-M14x1.5-B-E-W3
		9137	1.50	.43	.75	33,2	17,20	

¹ Suitable liquid / plastic sealant required.

Alternative materials and surface finishings are available upon request. Contact STAUFF for further information.
Torque recommendations for Steel mating material.

For further information on Seal Types,
please see page 74-77.

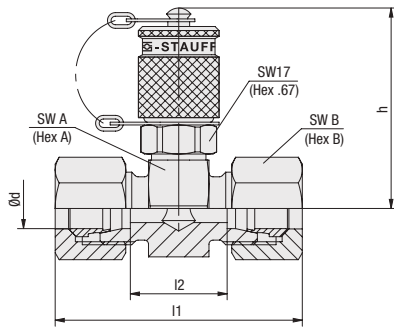
**Test Coupling with Straight 24° Fitting
SMK-15 Type G**
A

Series	PN (bar/PSI)	Pipe Ød	Dimensions (mm/in)					Weight (kg/lbs) ca. per 100 ¹	Ordering Codes (Standard Option) ²
			~l1 ³	l2	h	Hex A	Hex B		
L	315 4568	6	51	21	49	24	14	14,20	SMK-15-06L-G-W3-MS
			2.01	.83	1.93	.94	.55	31.24	
		8	51	21	49	24	17	15,40	SMK-15-08L-G-W3-MS
			2.01	.83	1.93	.94	.67	33.88	
		10	53	23	49	24	19	17,20	SMK-15-10L-G-W3-MS
			2.09	.91	1.93	.94	.75	37.84	
		12	53	23	50,5	27	22	19,80	SMK-15-12L-G-W3-MS
			2.09	.91	1.99	1.06	.87	43.56	
		15	55	25	52	30	27	25,50	SMK-15-15L-G-W3-MS
			2.17	.98	2.05	1.18	1.06	56.10	
		18	57	24	53	32	32	31,40	SMK-15-18L-G-W3-MS
			2.24	.94	2.09	1.26	1.26	69.08	
	160 2320	22	61	28	55	36	36	38,10	SMK-15-22L-G-W3-MS
			2.40	1.10	2.17	1.42	1.42	83.82	
		28	61	28	57,5	41	41	45,70	SMK-15-28L-G-W3-MS
			2.40	1.10	2.26	1.61	1.61	100.54	
		35	69	26	60	46	50	65,00	SMK-15-35L-G-W3-MS
			2.72	1.02	2.36	1.81	1.97	143.00	
42	71	25	64,5	55	60	87,40	SMK-15-42L-G-W3-MS		
	2.80	.98	2.54	2.17	2.36	192.28			
S	630 9137	6	55	25	49	24	17	17,00	SMK-15-06S-G-W3-MS
			2.17	.98	1.93	.94	.67	37.40	
		8	55	25	49	24	19	18,00	SMK-15-08S-G-W3-MS
			2.17	.98	1.93	.94	.75	39.60	
		10	57	24	49	24	22	20,60	SMK-15-10S-G-W3-MS
			2.24	.94	1.93	.94	.87	45.32	
	12	57	24	49	24	24	21,60	SMK-15-12S-G-W3-MS	
		2.24	.94	1.93	.94	.94	47.52		
	14	63	27	50,5	27	27	27,70	SMK-15-14S-G-W3-MS	
		2.50	1.06	1.99	1.06	1.06	60.94		
	400 5801	16	63	26	52	30	30	32,50	SMK-15-16S-G-W3-MS
			2.50	1.02	2.05	1.18	1.18	71.50	
		20	69	26	55	36	36	45,40	SMK-15-20S-G-W3-MS
			2.72	1.02	2.17	1.42	1.42	99.88	
		25	75	27	57,5	41	46	74,60	SMK-15-25S-G-W3-MS
			2.95	1.06	2.26	1.61	1.81	164.12	
	30	81	28	60	46	50	85,90	SMK-15-30S-G-W3-MS	
		3.19	1.10	2.36	1.81	1.97	188.98		
315 4568	38	91	29	64,5	55	60	7,40	SMK-15-38S-G-W3-MS	
		3.58	1.14	2.54	2.17	2.36	16.28		

Ordering Codes
***SMK*-15*-18L*-G*-SK*-W3*-MS**

* Type	Test Coupling with Ball Check	SMK
* Series	STAUFF Test 15 (Connection Thread M16x1,5)	-15
* Outside Tube Diameter	acc. to dimension table	-18
* Series	Light Series	L
	Heavy Series	S
* Seal Material	FKM (Viton®) EPDM	none -E
* Connection	Straight 24° Fitting	-G
* Protection Cap	Knurled protection cap	-
	Hexagonal protection cap	-SK
* Material Code	Steel, zinc/nickel-plated	-W3
	Stainless Steel V2A - 1.4305 (AISI 303)	-W4
	Stainless Steel V4A - 1.4571 (AISI 316 Ti)	-W5
* Assembling / Kitting	Fitting body only	-
	Fitting body supplied with Cutting rings and union nuts	-MS
	Fitting body supplied with soft-sealing cutting rings and union nuts	-MSV

¹ Weight including cutting rings and union nuts.

² Standard option: Fitting body supplied with Cutting rings and union nuts.

³ Approximate dimension in assembled condition.

Port acc. to ISO 8434-1 / DIN 2353

Alternative materials and surface finishings are available upon request. Contact STAUFF for further information.

**Test Coupling with 24° Taper / O-ring (DKO)
SMK-15 Type K**

A

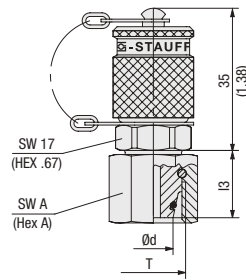

Version A

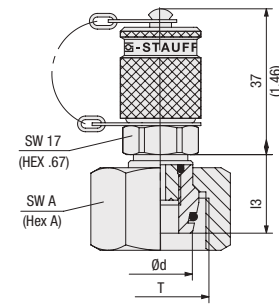

Version B

Ordering Codes

***SMK*-15*-18L*-B*-K*-GS*-SK*-W3**

* Type	Test Coupling with Ball Check	SMK
* Series	STAUFF Test 20 (Connection Thread M16x1,5)	-15
* Outside Tube Diameter	acc. to dimension table	-18
* Series	Light Series	L
	Heavy Series	S
* Seal Material	NBR (Buna-N®)	-B
	FKM (Viton®)	-V
	EPDM	-E
* Connection	24° Taper / O-ring (DKO)	-K
* Design	One-piece design (Version A)	-
	Screwed design (Version B)	-GS
* Protection Cap	Knurled protection cap	-
	Hexagonal protection cap	-SK
* Material Code	Steel, zinc/nickel-plated	-W3
	Stainless Steel V2A - 1.4305 (AISI 303)	-W4
	Stainless Steel V4A - 1.4571 (AISI 316 Ti)	-W5

Series	PN (^{mm} / _{IPS})	Pipe Ød	Dimensions (^{mm} / _{in})			Thread	Version	Weight (^{kg} / _{lbs}) ca. per 100	Ordering Codes (Standard Option)
			I3	Hex A	T				
L	315 4568	6	15,5	14	M12 x 1,5	A	8,00	SMK-15-06L-B-K-W3	
			.61	.55			17,60		
		8	15,5	17	M14 x 1,5	A	8,00	SMK-15-08L-B-K-W3	
			.61	.67			17,60		
		10	16,5	19	M16 x 1,5	A	9,30	SMK-15-10L-B-K-W3	
			.65	.75			20,46		
	12	17,5	22	M18 x 1,5	A	10,60	SMK-15-12L-B-K-W3		
		.69	.87			23,32			
	15	21	27	M22 x 1,5	B	13,00	SMK-15-15L-B-K-GS-W3		
		.83	1.06			28,60			
	18	19,5	32	M26 x 1,5	B	16,30	SMK-15-18L-B-K-GS-W3		
		.77	1.26			35,86			
	160 2320	22	20,5	36	M30 x 2	B	19,00	SMK-15-22L-B-K-GS-W3	
			.81	1.42			41,80		
28		25	41	M36 x 2	B	26,50	SMK-15-28L-B-K-GS-W3		
		.98	1.61			58,30			
35		30	50	M45 x 2	B	40,43	SMK-15-35L-B-K-GS-W3		
		1.18	1.97			88,95			
42	31	60	M52 x 2	B	58,40	SMK-15-42L-B-K-GS-W3			
	1.22	2.36			128,48				
S	630 9137	6	14,5	17	M14 x 1,5	A	7,90	SMK-15-06S-B-K-W3	
			.57	.67			17,38		
		8	16,5	19	M16 x 1,5	A	8,80	SMK-15-08S-B-K-W3	
			.65	.75			19,36		
		10	16,5	22	M18 x 1,5	A	10,30	SMK-15-10S-B-K-W3	
			.65	.87			22,66		
	12	17,5	24	M20 x 1,5	A	11,90	SMK-15-12S-B-K-W3		
		.69	.94			26,18			
	14	19,5	27	M22 x 1,5	B	14,60	SMK-15-14S-B-K-GS-W3		
		.77	1.06			32,12			
	400 5801	16	18	30	M24 x 1,5	B	15,20	SMK-15-16S-B-K-GS-W3	
			.71	1.18			33,44		
		20	24	36	M30 x 2	B	22,20	SMK-15-20S-B-K-GS-W3	
			.94	1.42			48,84		
25		26	46	M36 x 2	B	35,50	SMK-15-25S-B-K-GS-W3		
		1.02	1.81			78,10			
30	30	50	M42 x 2	B	43,40	SMK-15-30S-B-K-GS-W3			
	1.18	1.97			95,48				
315 4568	38	34	60	M52 x 2	B	63,80	SMK-15-38S-B-K-GS-W3		
		1.34	2.36			140,36			

With 24° Taper / O-ring (DKO) Connection acc. to ISO 8434-1 / DIN 2353
Alternative materials and surface finishings are available upon request. Contact STAUFF for further information.

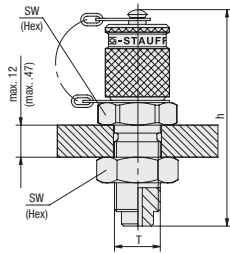
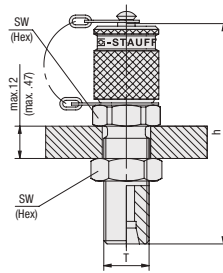
**Bulkhead
SSK-15**
A

Version A

Version B

Thread	Dimensions (mm/in)		Version	Weight (kg/lbs) ca. per 100	Ordering Codes (Standard Option)
	T	h Hex			
M16 x 1,5	72	19	A	11,20	SSK-15-W3
	2.83	.75		24.64	
M16 x 1,5 ¹	72	22	B	12,30	SSK-15/08S-W3
	2.83	.87		27.06	

Also available for gaseous media: Type SSKK

¹ Compression ring assembly 08S according to ISO 8434-1 / DIN 2353

Standard option: With Hexagon Lock Nut.

Standard option - Version B: Excluding cutting rings and union nuts

Alternative materials and surface finishings are available upon request. Contact STAUFF for further information.

Ordering Codes
***SSK*-15/08S*-SK*-W3**

* Type	Bulkhead with Ball Check	SSK
* Series	STAUFF Test 15 (Connection Thread M16x1,5)	-15
* Outside Tube Diameter	acc. to dimension table	/08
* Series	Heavy Series	S
* Seal Material	FKM (Viton®) EPDM	none -E
* Protection Cap	Knurled protection cap Hexagonal protection cap	- -SK
* Material Code	Steel, zinc/nickel-plated	-W3
	Stainless Steel V2A - 1.4305 (AISI 303)	-W4
	Stainless Steel V4A - 1.4571 (AISI 316 Ti)	-W5

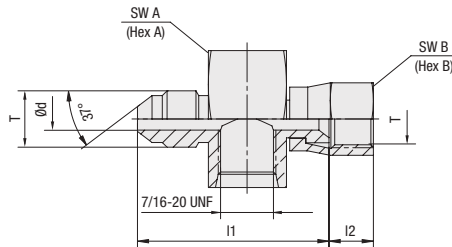
**Swivel Run Tee with 37° JIC Connection
SGV-JIC Type FM**

Pipe Ø inch	JIC- Size	Dimensions (mm/in)						Thread T inch	Weight (kg/lbs) ca. per 100	Ordering Codes (Standard Option)
		Ø d	l1	l2	Hex A	Hex B				
1/4	04	4,37	37,74	8,74	27	14,29	7/16-20 UNF	8,96	SGV-7/16UNF-04-JIC1/4-FM-W66	
		.17	1.49	.34	1.06	.56		19.71		
3/8	06	7,54	40,01	9,53	27	17,46	9/16-18 UNF	9,60	SGV-7/16UNF-06-JIC3/8-FM-W66	
		.30	1.58	.38	1.06	.69		21.12		
1/2	08	9,93	44,65	10,72	27	22,23	3/4-16 UNF	11,20	SGV-7/16UNF-08-JIC1/2-FM-W66	
		.39	1.76	.42	1.06	.88		24.64		
5/8	10	12,29	48,26	12,70	28,58	25,40	7/8-14 UNF	17,10	SGV-7/16UNF-10-JIC5/8-FM-W66	
		.48	1.90	.50	1.13	1.00		37.62		
3/4	12	15,47	51,33	14,45	31,75	31,75	1-1/16-12 UNF	20,40	SGV-7/16UNF-12-JIC3/4-FM-W66	
		.61	2.02	.57	1.25	1.25		44.88		
1	16	21,44	57,30	15,09	38,10	38,10	1-5/16-12 UNF	30,80	SGV-7/16UNF-16-JIC1-FM-W66	
		.84	2.26	.59	1.50	1.50		67.76		

Alternative materials and surface finishings are available upon request. Contact STAUFF for further information.

Ordering Codes
***SGV*-7/16UNF*-12*-JIC3/4*-FM*-W66**

* Type	Swivel Run Tee	SGV
* Port Connection	acc. to dimension table	-7/16UNF
* JIC Size	acc. to dimension table	-12
* Connection	37° JIC Connection	-JIC
* Outside Tube Diameter	acc. to dimension table	3/4
* Connection	Female/Male Thread	-FM
* Material Code	Carbon Steel, zinc-plated and thick-film passivated	-W66

**Test Adaptor
SAD-15**

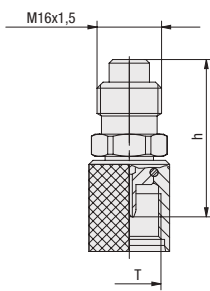

Version A

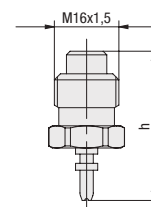

Version B

Ordering Codes

***SAD*-15/20*-B*-W3**

* Type	Test Adaptor	SAD
* Connection Type	Version A	-15/20
	Version B	-15/12
	Version B	-15/10
* Seal Material	FKM (Viton®)	none
	EPDM	-E
* Material Code	Steel, zinc/nickel-plated	-W3
	Stainless Steel V2A - 1.4305 (AISI 303)	-W4
	Stainless Steel V4A - 1.4571 (AISI 316 Ti)	-W5

Thread	Dimensions (mm/in)	Version	Weight (kg/lbs) ca. per 100	Ordering Codes (Standard Option)
M16 x 2	39	A	6,20	SAD-15/20-W3
	1.54		13.64	
S12 ¹	39	A	5,40	SAD-15/12-W3
	1.54		11.88	
Plug in	37	B	3,20	SAD-15/10-W3
	1.46		7.05	

¹ Special thread: buttress thread S12,65 x1,5

Alternative materials and surface finishings are available upon request. Contact STAUFF for further information.

**Gauge Adaptor
SMA-15**



**Direct Gauge Adaptor
SMD-15**

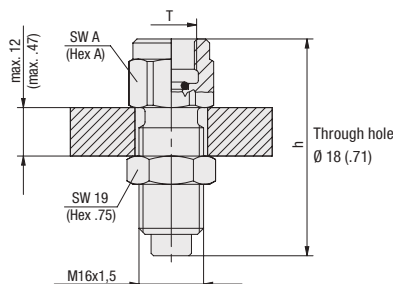

Gauge Adaptor SMA-15

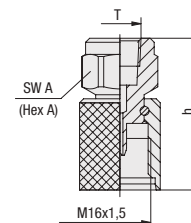

Direct Gauge Adaptor SMD-15

Ordering Codes

***SMA*-15*-G1/4*-B*-OR*-W3**

* Type	Gauge Adaptor	SMA
* Series	STAUFF Test 15 (Connection Thread M16x1,5)	-15
* Thread	acc. to dimension table	-G1/4
* Seal Material	NBR (Buna-N®)	-B
	FKM (Viton®)	-V
	EPDM	-E
	Seal Type without O-ring	none
* Seal Type	with O-ring	-OR
* Material Code	Steel, zinc/nickel-plated	-W3
	Stainless Steel V2A - 1.4305 (AISI 303)	-W4
	Stainless Steel V4A - 1.4571 (AISI 316 Ti)	-W5

Thread	Dimensions (mm/in)	Hex A	Weight (kg/lbs) ca. per 100	Ordering Codes (Standard Option)
G1/4	54	19	7,40	SMA-15-G1/4-B-OR-W3
	2.13	.75	16.28	
G1/2	64	27	12,20	SMA-15-G1/2-B-OR-W3
	2.52	1.06	26.84	
1/4 NPT	54	19	7,80	SMA-15-1/4NPT-W3
	2.13	.75	17.16	
1/2 NPT	64	27	14,5	SMA-15-1/2NPT-W3
	2.52	1.06	31.97	
G1/4	41	19	5,60	SMD-15-G1/4-B-OR-W3
	1.61	.75	12.32	
G1/2	51	27	9,90	SMD-15-G1/2-B-OR-W3
	2.01	1.06	21.78	
1/4 NPT	41	19	5,60	SMD-15-1/4NPT-W3
	1.61	.75	12.32	
1/2 NPT	51	27	13,50	SMD-15-1/2NPT-W3
	2.01	1.06	29,76	

Standard option - SMA-15: With Hexagon Lock Nut.

Alternative materials and surface finishings are available upon request. Contact STAUFF for further information. Snubber on request.

Dimensional drawings: All dimensions in mm (in).

Colour Marking Rings for Test Couplings and Test Hose Assemblies

A



Hydraulic test couplings and test hose assemblies of the STAUFF Test 20 and STAUFF Test 15 series made of steel and stainless steel can optionally be equipped with colour marking rings.

Typical areas of application:

- distinguish between hydraulic circuits
- distinguish pressure ranges (suction line, pressure line, return line, etc.)
- distinguish between test intervals and test times
- distinguish between types of media (oil, gas, water, etc.)
- distinguish between types of couplings (ball check or poppet valve)
- Marking of suitable positions for sampling
- Marking of suitable positions for filling or venting the system

The colour marking rings are available as accessories in currently five standard colours:

Colour	RAL Code	Ordering Codes	Packaging Unit
	RAL 9005	MR-TEST-17.1x1x4-K-RD	25
	RAL 3000	MR-TEST-17.1x1x4-K-BK	25
	RAL 1018	MR-TEST-17.1x1x4-K-YE	25
	RAL 5005	MR-TEST-17.1x1x4-K-BU	25
	RAL 6002	MR-TEST-17.1x1x4-K-GN	25

Depending on the required quantities, other colours are also available on request. Please note: Slight colour deviations may occur due to production.

If required, the colour marking rings can be applied by the user very easily, flexibly and without the need for tools. Retrofitting on already installed couplings and test hose lines is also possible without any problems.

The rings are placed in the standard groove of the knurled protection and connection caps of test couplings and test hose connectors. The high resistance of the knurled caps made of steel and stainless steel to environmental influences is not limited by the use of the rings at all.

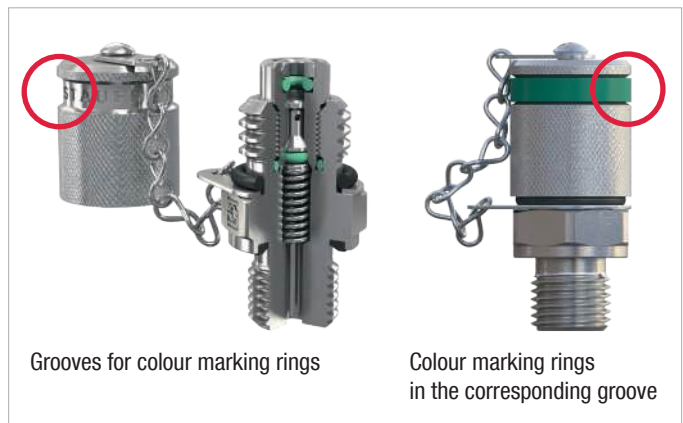

The colour marking rings are manufactured from thermoplastic polyurethane (TPU). TPU is a lightweight, elastic material with very good abrasion and wear resistance, paired with high resilience.

Selecting the right material was one of the crucial criteria for the development of the colour marking rings. Resistance to all media generally used in hydraulic systems was therefore of great importance. In addition to this, the ring material is also resistant to other oils, greases and a number of common solvents. The thermoplastic polyurethane (TPU) used is thermally stable and also features excellent UV resistance.

Test Coupling with Piston Valve
SKK-12

A



Test Coupling with Piston Valve SKK-12

A

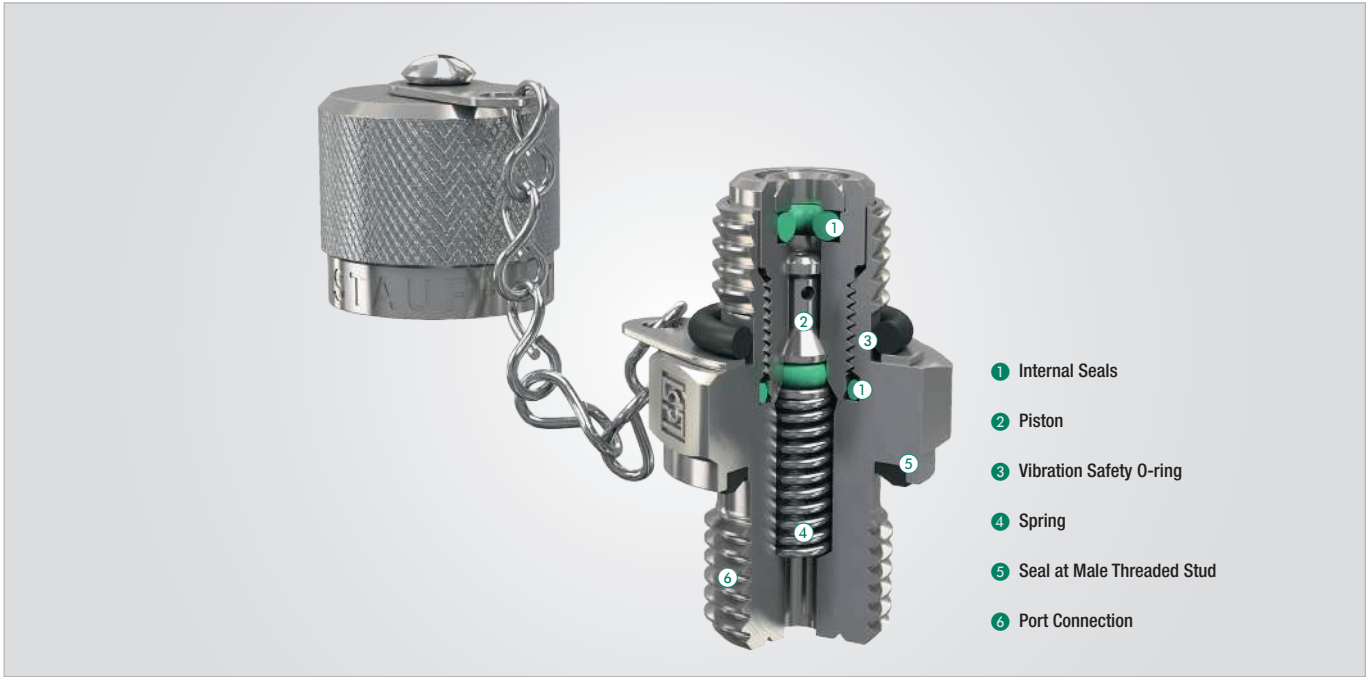

- 1 Internal Seals
- 2 Piston
- 3 Vibration Safety O-ring
- 4 Spring
- 5 Seal at Male Threaded Stud
- 6 Port Connection

Fast Coupling for

- Monitoring and control of pressure
- Venting
- Sampling in high- and low-pressure systems
- Filling of accumulators (special filling-version)

Advantages

- Test system at working pressure
- Leakproof connection before **piston valve** is open
- Simple connection to measurement, control and switching devices
- Self locking metal protective cap

Working Pressure

- Max. working pressure 630 bar / 9137 PSI
For SKK Type G and K the recommended working pressure of fitting manufacturer should be noted.
- Connection under pressure up to 400 bar / 5801 PSI max.

DVGW

- DVGW registration as test points for gas pressure controlsystems, issued by the German Technical and Scientific Association for Gas and Water
- The DVGW approval relates solely to the SKK-12 and SKK-20 series with connection types:
 - M8x1-V-A-DVGW
 - M10x1-V-A-DVGW
 - 1/8NPT-V-D-DVGW
 - 1/4NPT-V-D-DVGW

Materials

▪ Metal Parts:

Standard material: Steel, zinc/nickel-plated = **W3**
 Optional:
 Stainless Steel **W4** (1.4305 / AISI 303) on request
 Stainless Steel **W5** (1.4571 / AISI 316Ti) on request

▪ Seal Types:

B = NBR (Buna-N®)

(Temperature range -20 °C ... +100°C / -4 °F ... +212 °F)

Note: Internal sealings made of FKM, even for standard NBR-type.

V = FKM (Viton®)

(Temperature range -20 °C ... +200 °C / -4 °F ... +392 °F)

E = EPDM Ethylene Propylene Diene Monomer Rubber

(for Brake fluid,
 Temperature range -40 °C ... +150 °C / -40 °F ... +302 °F)





Vibration safety O-ring made of NBR (Buna-N®).

Media

- Suitable for hydraulic oils and other Mineral oil based fluids (Check compatibility of seal material)
- For use with other liquid media please contact STAUFF
- In case of ultimate tightness requirements for gaseous media, a special Gas-type is available

Protection Cap

- The complete STAUFF-Test-12-type-SKK range is also available with a plastic protection cap.

SKK-12 Test Coupling with Male Threaded Stud	SKK-12 Type G Test Coupling with Straight 24° Fitting	SMK-12 Type K Test Coupling With 24° Taper / O-ring (DKO)	SSKK-12 Bulkhead
			

Test Coupling with Male Threaded Stud SKK-12

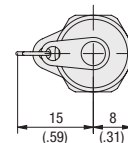
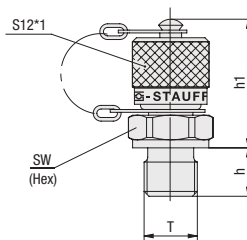

Ordering Codes

SKK-12*-G1/4*-B*-C*-KK*-W3

* Type	Test Coupling with Piston Valve	SKK
* Series	STAUFF Test 12 (Connection Thread S12,65 x 1,5)	-12
* Port Connection	acc. to dimension table	-G1/4
* Seal Material	NBR (Buna-N®)	-B
	FKM (Viton®)	-V
	EPDM	-E
	Seal Type B and D	none
* Seal Type	O-ring Type A	-A
	Metal Joint Type B	-B
	Elastomeric Sealing Type C	-C
	Taper Type D	-D
	O-ring Type E	-E
* Protection Cap	Knurled protection cap	-
	Plastic protection cap	-KK
* Material Code	Steel, zinc/nickel-plated	-W3
	Stainless Steel V2A - 1.4305 (AISI 303)	-W4
	Stainless Steel V4A - 1.4571 (AISI 316 Ti)	-W5

Seal Type



O-ring Type A



Metal Joint Type B



Elastomeric Sealing Type C



Taper Type D¹



O-ring Type E

Thread	Seal Type	Working Pressure (^{bar} / _{psi})	Dimensions (^{mm} / _{in})			Torque (^{Nm} / _{ft-lb}) ca.	Weight (^{kg} / _{lbs}) ca. per 100	Ordering Codes (Standard Option)
			h1	h2	Hex Thread T			
M8 x 1	Type A	250	38	8,5	14	6	5,50	SKK-12-M8x1-B-A-W3
		3625	1.50	.33	.55	4.4	12.10	
M10 x 1	Type A	630	35	9,8	14	12	5,30	SKK-12-M10x1-B-A-W3
		9137	1.38	.39	.67	8.8	11.66	
M12 x 1,5	Type A	630	31	12	17	35	5,60	SKK-12-M12x1.5-B-W3
		9137	1.22	.47	.67	25.8	12.35	
M14 x 1,5	Type A	630	31	12	19	55	6,40	SKK-12-M14x1.5-B-W3
		9137	1.22	.47	.75	40.6	14.08	
M16 x 1,5	Type B	630	31	12	22	70	8,10	SKK-12-M16x1.5-B-W3
		9137	1.22	.47	.87	51.6	17.82	
G1/4	Type B	630	30	12	19	55	6,10	SKK-12-G1/4-B-W3
		9137	1.18	.47	.75	40.6	13.42	
G3/8	Type B	630	31	12	22	90	7,80	SKK-12-G3/8-B-W3
		9137	1.22	.47	.87	66.4	17.16	
M12 x 1,5	Type C	630	31	12	17	35	5,70	SKK-12-M12x1.5-B-C-W3
		9137	1.22	.47	.67	25.8	12.54	
G1/8	Type C	400	40	8	14	18	5,90	SKK-12-G1/8-B-C-W3
		5801	1.57	.31	.55	13.3	12.98	
G1/4	Type C	630	31	12	19	45	6,30	SKK-12-G1/4-B-C-W3
		9137	1.22	.47	.75	33.2	13.86	
R1/8 K	Type D ²	400	33	8	17		5,00	SKK-12-R1/8K-D-W3
		5801	1.30	.31	.55		11.00	
R1/4 K	Type D ²	630	30	12	17		5,40	SKK-12-R1/4K-D-W3
		9137	1.18	.47	.55		11.88	
1/8 NPT	Type D ²	400	33	10	14		5,00	SKK-12-1/8NPT-D-W3
		5801	1.30	.39	.55		11.00	
1/4 NPT	Type D ²	630	28	15	14		5,50	SKK-12-1/4NPT-D-W3
		9137	1.10	.59	.55		12.10	
5/16-24 UNF	Type E	400	38	7,5	14	8	5,40	SKK-12-5/16UNF-B-E-W3
		5801	1.50	.30	.55	5.9	11.88	
7/16-20 UNF	Type E	630	33	9,1	17	20	5,90	SKK-12-7/16UNF-B-E-W3
		9137	1.30	.36	.67	14.7	12.98	
1/2-20 UNF	Type E	630	32	9,2	17	25	5,90	SKK-12-1/2UNF-B-E-W3
		9137	1.26	.36	.67	18.4	12.98	
9/16-18 UNF	Type E	630	31	10	19	35	6,30	SKK-12-9/16UNF-B-E-W3
		9137	1.22	.39	.75	25.8	13.86	
M12 x 1,5	Type E	630	32	11	17	35	5,80	SKK-12-M12x1.5-B-E-W3
		9137	1.26	.43	.67	25.8	12.79	

¹ Special thread: buttress thread S12,65 x 1,5

² Suitable liquid / plastic sealant required.

Alternative materials and surface finishings are available upon request. Contact STAUFF for further information.
Torque recommendations for Steel mating material.

For further information on Seal Types,
please see page 74-77.

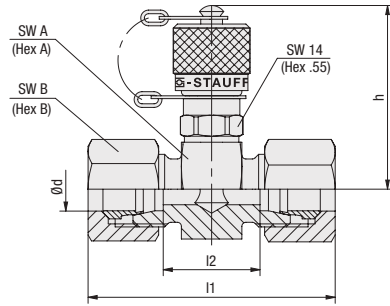
**Test Coupling with Straight 24° Fitting
SKK-12 Type G**
A

Series	PN (^{bar} / _{PSI})	Pipe Ød	Dimensions (^{mm} / _{in})					Weight (^{kg} / _{lbs}) ca. per 100 ¹	Ordering Codes (Standard Option) ²
			~I ³	I2	h	Hex A	Hex B		
L	315 4568	6	51	21	46	24	14	13,00	SKK-12-06L-G-W3-MS
			2.01	.83	1.81	.94	.55	28.60	
		8	51	21	46	24	17	14,10	SKK-12-08L-G-W3-MS
			2.01	.83	1.81	.94	.67	31.02	
		10	53	23	46	24	19	15,30	SKK-12-10L-G-W3-MS
			2.09	.91	1.81	.94	.75	33.66	
	12	53	23	47,5	27	22	18,20	SKK-12-12L-G-W3-MS	
		2.09	.91	1.87	1.06	.87	40.04		
	15	55	25	49	30	27	24,50	SKK-12-15L-G-W3-MS	
		2.17	.98	1.92	1.18	1.06	53.90		
	18	57	24	50	32	32	19,00	SKK-12-18L-G-W3-MS	
		2.24	.94	1.97	1.26	1.26	41.89		
	160 2320	22	61	28	52	36	36	32,20	SKK-12-22L-G-W3-MS
			2.40	1.10	2.05	1.42	1.42	70.84	
28		61	28	54,5	41	41	44,00	SKK-12-28L-G-W3-MS	
		2.40	1.10	2.15	1.61	1.61	96.80		
35		69	26	57	46	50	39,50	SKK-12-35L-G-W3-MS	
	2.72	1.02	2.24	1.81	1.97	87.08			
42	71	25	61,5	55	60	85,80	SKK-12-42L-G-W3-MS		
S	630 9137	6	55	25	46	24	17	15,60	SKK-12-06S-G-W3-MS
			2.17	.98	1.81	.94	.67	34.32	
		8	55	25	46	24	19	16,50	SKK-12-08S-G-W3-MS
			2.17	.98	1.81	.94	.75	36.30	
		10	57	24	46	24	22	19,04	SKK-12-10S-G-W3-MS
			2.24	.94	1.81	.94	.87	41.89	
	12	57	24	46	24	24	20,90	SKK-12-12S-G-W3-MS	
		2.24	.94	1.81	.94	.94	45.98		
	14	63	27	47,5	27	27	27,00	SKK-12-14S-G-W3-MS	
		2.50	1.06	1.87	1.06	1.06	59.40		
	400 5801	16	63	26	49	30	30	31,10	SKK-12-16S-G-W3-MS
			2.50	1.02	1.93	1.18	1.18	68.42	
		20	69	26	52	36	36	48,20	SKK-12-20S-G-W3-MS
			2.72	1.02	2.05	1.42	1.42	106.04	
		25	75	27	54,5	41	46	73,50	SKK-12-25S-G-W3-MS
			2.95	1.06	2.15	1.61	1.81	161.70	
	30	81	28	57	46	50	85,45	SKK-12-30S-G-W3-MS	
		3.19	1.10	2.24	1.81	1.97	187.99		
315 4568	38	91	29	61,5	55	60	63,20	SKK-12-38S-G-W3-MS	
		3.58	1.14	2.42	2.17	2.36	139.33		

Ordering Codes
***SKK*-12*-18L*-G*-SK*-W3*-MS**

* Type	Test Coupling with Piston Valve	SKK
* Series	STAUFF Test 12 (Connection Thread S12,65 x 1,5)	-12
* Outside Tube Diameter	acc. to dimension table	-18
* Series	Light Series Heavy Series	L S
* Seal Material	FKM (Viton®) EPDM	none -E
* Connection	Straight 24° Fitting	-G
* Protection Cap	Knurled protection cap	-
* Material Code	Steel, zinc/nickel-plated	-W3
	Stainless Steel V2A - 1.4305 (AISI 303)	-W4
	Stainless Steel V4A - 1.4571 (AISI 316 Ti)	-W5
* Assembling / Kitting	Fitting body only	-
	Fitting body supplied with Cutting rings and union nuts	-MS
	Fitting body supplied with soft-sealing cutting rings and union nuts	-MSV

¹ Weight including cutting rings and union nuts.

² Standard option: Fitting body supplied with Cutting rings and union nuts.

³ Approximate dimension in assembled condition.

Port acc. to ISO 8434-1 / DIN 2353

Alternative materials and surface finishings are available upon request. Contact STAUFF for further information.

**Test Coupling with 24° Taper / O-ring (DKO)
SKK-12 Type K**

A

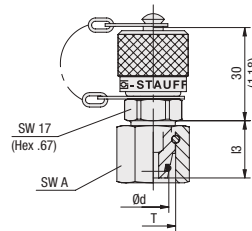

Version A

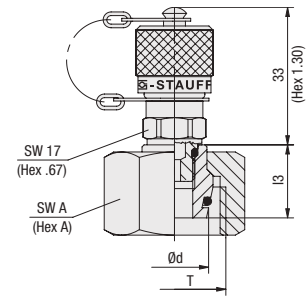

Version B

Ordering Codes

***SKK*-12*-18L*-B*-K*-GS*-SK*-W3**

- * Type Test Coupling with Piston Valve **SKK**
- * Series STAUFF Test 12 **-12**
(Connection Thread S12,65 x 1,5)
- * Outside Tube Diameter acc. to dimension table **-18**
- * Series Light Series **L**
Heavy Series **S**
- * Seal Material NBR (Buna-N®) **-B**
FKM (Viton®) **-V**
EPDM **-E**
- * Connection 24° Taper / O-ring (DKO) **-K**
- * Design One-piece design (Version A) **-**
Screwed design (Version B) **-GS**
- * Protection Cap Knurled protection cap **-**
- * Material Code Steel, zinc/nickel-plated **-W3**
Stainless Steel V2A - 1.4305 (AISI 303) **-W4**
Stainless Steel V4A - 1.4571 (AISI 316 Ti) **-W5**

Series	PN (^{mm} / _{psi})	Pipe Ød	Dimensions (^{mm} / _{in})			Thread	Version	Weight (^{kg} / _{lbs}) ca. per 100	Ordering Codes (Standard Option)
			I3	Hex A	T				
L	315 4568	6	15,5	14	M12 x 1,5	A	6,40	SKK-12-06L-B-K-W3	
			.61	.55			14,08		
		8	15,5	17	M14 x 1,5	A	6,50	SKK-12-08L-B-K-W3	
			.61	.67			14,30		
		10	16,5	19	M16 x 1,5	A	7,90	SKK-12-10L-B-K-W3	
			.65	.75			17,38		
	12	17,5	22	M18 x 1,5	A	9,00	SKK-12-12L-B-K-W3		
		.69	.87			19,80			
	15	21	27	M22 x 1,5	B	11,70	SKK-12-15L-B-K-GS-W3		
		.83	1.06			25,74			
	18	19,5	32	M26 x 1,5	B	19,00	SKK-12-18L-B-K-GS-W3		
		.77	1.26			41,80			
	160 2320	22	20,5	36	M30 x 2	B	18,70	SKK-12-22L-B-K-GS-W3	
			.81	1.42			41,14		
28		25	41	M36 x 2	B	24,70	SKK-12-28L-B-K-GS-W3		
		.98	1.61			54,34			
35		30	50	M45 x 2	B	39,50	SKK-12-35L-B-K-GS-W3		
		1.18	1.97			86,90			
42	31	60	M52 x 2	B	85,80	SKK-12-42L-B-K-GS-W3			
	1.22	2.36			189,16				
S	630 9137	6	14,5	17	M14 x 1,5	A	6,60	SKK-12-06S-B-K-W3	
			.57	.67			14,52		
		8	16,5	19	M16 x 1,5	A	7,70	SKK-12-08S-B-K-W3	
			.65	.75			16,94		
		10	16,5	22	M18 x 1,5	A	8,80	SKK-12-10S-B-K-W3	
	.65		.87	19,36					
	12	17,5	24	M20 x 1,5	A	10,50	SKK-12-12S-B-K-W3		
		.69	.94			23,10			
	14	19,5	27	M22 x 1,5	B	12,40	SKK-12-14S-B-K-GS-W3		
		.77	1.06			27,28			
	400 5801	16	18	30	M24 x 1,5	B	13,70	SKK-12-16S-B-K-GS-W3	
			.71	1.18			30,14		
		20	24	36	M30 x 2	B	19,80	SKK-12-20S-B-K-GS-W3	
			.94	1.42			43,56		
25		26	46	M36 x 2	B	35,20	SKK-12-25S-B-K-GS-W3		
	1.02	1.81	77,44						
30	30	50	M42 x 2	B	41,70	SKK-12-30S-B-K-GS-W3			
	1.18	1.97			91,74				
315 4568	38	34	60	M52 x 2	B	63,20	SKK-12-38S-B-K-GS-W3		
		1.34	2.36			139,04			

With 24° Taper / O-ring (DKO) Connection acc. to ISO 8434-1 / DIN 2353

Alternative materials and surface finishings are available upon request. Contact STAUFF for further information.

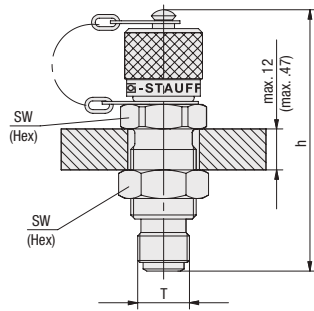
**Bulkhead
SSKK-12**
A

Thread	Dimensions (mm/in)		Weight (kg/lbs) ca. per 100	Ordering Codes (Standard Option)
T	h	Hex		
S12 ¹	63	19	10,30	SSKK-12-W3
	2.48	0.75	22.66	

¹ Special thread: buttress thread S12,65 x 1,5

Standard option: With Hexagon Lock Nut.

Alternative materials and surface finishings are available upon request. Contact STAUFF for further information.

Ordering Codes
***SSKK*-12*-SK*-W3**

* Type	Bulkhead with Piston Valve	SSKK
* Series	STAUFF Test 12 (Connection Thread S12,65 x 1,5)	-12
* Seal Material	FKM (Viton®) EPDM	none -E
* Protection Cap	Knurled protection cap	-
* Material Code	Steel, zinc/nickel-plated	-W3
	Stainless Steel V2A - 1.4305 (AISI 303)	-W4
	Stainless Steel V4A - 1.4571 (AISI 316 Ti)	-W5

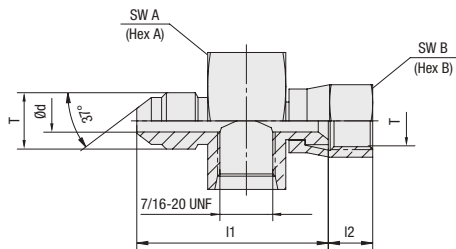
**Swivel Run Tee with 37° JIC Connection
SGV-JIC Type FM**

Pipe Ø inch	JIC- Size	Dimensions (mm/in)					Thread T inch	Weight (kg/lbs) ca. per 100	Ordering Codes (Standard Option)
		Ø d	l1	l2	Hex A	Hex B			
1/4	04	4,37	37,74	8,74	27	14,29	7/16-20 UNF	8,96	SGV-7/16UNF-04-JIC1/4-FM-W66
		.17	1.49	.34	1.06	.56		19.71	
3/8	06	7,54	40,01	9,53	27	17,46	9/16-18 UNF	9,60	SGV-7/16UNF-06-JIC3/8-FM-W66
		.30	1.58	.38	1.06	.69		21.12	
1/2	08	9,93	44,65	10,72	27	22,23	3/4-16 UNF	11,20	SGV-7/16UNF-08-JIC1/2-FM-W66
		.39	1.76	.42	1.06	.88		24.64	
5/8	10	12,29	48,26	12,70	28,58	25,40	7/8-14 UNF	17,10	SGV-7/16UNF-10-JIC5/8-FM-W66
		.48	1.90	.50	1.13	1.00		37.62	
3/4	12	15,47	51,33	14,45	31,75	31,75	1-1/16-12 UNF	20,40	SGV-7/16UNF-12-JIC3/4-FM-W66
		.61	2.02	.57	1.25	1.25		44.88	
1	16	21,44	57,30	15,09	38,10	38,10	1-5/16-12 UNF	30,80	SGV-7/16UNF-16-JIC1-FM-W66
		.84	2.26	.59	1.50	1.50		67.76	

Alternative materials and surface finishings are available upon request. Contact STAUFF for further information.

Ordering Codes
***SGV*-7/16UNF*-12*-JIC3/4*-FM*-W66**

* Type	Swivel Run Tee	SGV
* Port Connection	acc. to dimension table	-7/16UNF
* JIC Size	acc. to dimension table	-12
* Connection	37° JIC Connection	-JIC
* Outside Tube Diameter	acc. to dimension table	3/4
* Connection	Female/Male Thread	-FM
* Material Code	Carbon Steel, zinc-plated and thick-film passivated	-W66

**Test Adaptor
SAD-12**

A

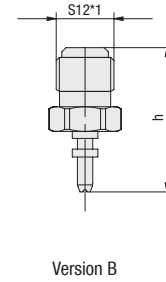
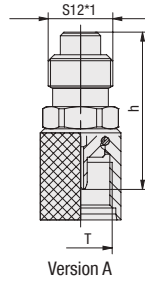

Ordering Codes

***SAD*-12/20*-W3**

* Type	Test Adaptor	SAD
* Connection Type	Version A	-12/20
	Version B	-12/10
* Seal Material	FKM (Viton®)	none
	EPDM	-E
* Material Code	Steel, zinc/nickel-plated	-W3
	Stainless Steel V2A - 1.4305 (AISI 303)	-W4
	Stainless Steel V4A - 1.4571 (AISI 316 Ti)	-W5

Thread	Dimensions (mm/in)	Version	Weight (kg/lbs) ca. per 100	Ordering Codes (Standard Option)
M16 x 2	33	A	4,70	SAD-12/20-W3
	1.30		10.34	
M16 x 1,5	33	A	4,60	SAD-12/15-W3
	1.30		10.12	
Plug in	31	B	1,80	SAD-12/10-W3
	1.22		3.96	

¹ Special thread: buttress thread S12,65 x1,5
Alternative materials and surface finishings are available upon request. Contact STAUFF for further information.

**Gauge Adaptor
SMA-12**

**Direct Gauge Adaptor
SMD-12**

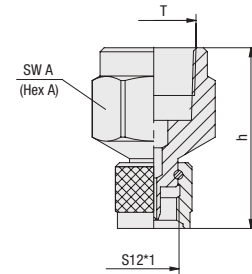
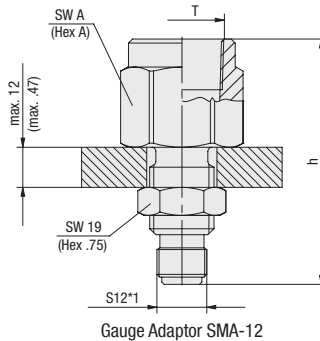

Gauge Adaptor SMA-12

Direct Gauge Adaptor SMD-12

Ordering Codes

***SMA*-12*-G1/4*-B*-OR*-W3**

* Type	Gauge Adaptor	SMA
* Series	STAUFF Test 12 (Connection Thread S12,65 x 1,5)	-12
* Thread	acc. to dimension table	-G1/4
* Seal Material	NBR (Buna-N®)	-B
	FKM (Viton®)	-V
	EPDM	-E
	Seal Type without O-ring	none
* Seal Type	with O-ring	-OR
* Material Code	Steel, zinc/nickel-plated	-W3
	Stainless Steel V2A - 1.4305 (AISI 303)	-W4
	Stainless Steel V4A - 1.4571 (AISI 316 Ti)	-W5

Thread	Dimensions (mm/in)	Hex A	Weight (kg/lbs) ca. per 100	Ordering Codes (Standard Option)
G1/4	51	19	6,70	SMA-12-G1/4-B-OR-W3
	2.01	.75	14.74	
G1/2	61	27	12,10	SMA-12-G1/2-B-OR-W3
	2.40	1.06	26.62	
1/4 NPT	51	19	6,70	SMA-12-1/4NPT-W3
	2.01	.75	14.74	
1/2 NPT	61	27	12,80	SMA-12-1/2NPT-W3
	2.40	1.06	28.16	
G1/4	35	19	5,20	SMD-12-G1/4-B-OR-W3
	1.38	.75	11.44	
G1/2	45	27	9,40	SMD-12-G1/2-B-OR-W3
	1.77	1.06	20.68	
1/4 NPT	35	19	5,10	SMD-12-1/4NPT-W3
	1.38	.75	11.22	
1/2 NPT	45	27	10,30	SMD-12-1/2NPT-W3
	1.77	1.06	22.66	

¹ Special thread: buttress thread S12,65 x1,5
Standard option - SMA-12: With Hexagon Lock Nut.
Alternative materials and surface finishings are available upon request. Contact STAUFF for further information.
Snubber on request.

Dimensional drawings: All dimensions in mm (in).

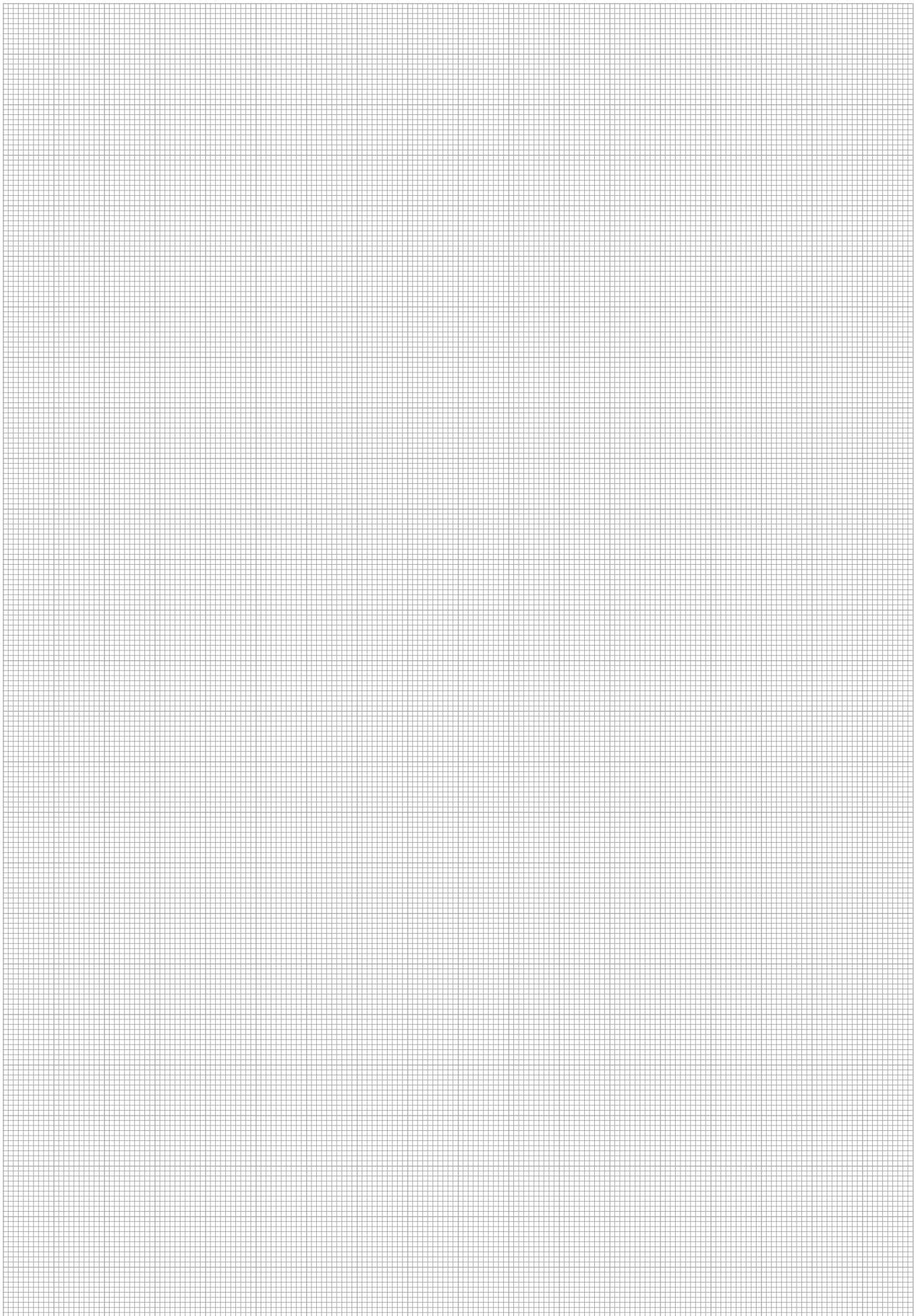

Test Coupling with Ball Check
SMK-10

A



Test Coupling with Ball Check
SMK-10

A



- 1 Internal Seals
- 2 Ball
- 3 Spring
- 4 Seal at Male Threaded Stud
- 5 Port Connection

Fast Coupling for

- Monitoring and control of pressure
- Venting
- Sampling in high- and low-pressure systems

Advantages

- Leak proof connection before **Ball Check** is open
- Simple connection to measurement, control and switching devices

Working Pressure

- Max. working pressure 400 bar / 5801 PSI
For SMK Type G and K the recommended working pressure of fitting manufacturer should be noted.

Materials

- **Metal Parts:**
Standard material: Steel, zinc/nickel-plated = **W3**
- **Ball:** Stainless Steel
- **Strap:** Polyethylene

▪ **Seal Types:**

B = NBR (Buna-N®)

(Temperature range -20 °C ... +100 °C / -4 °F ... +212 °F)

Note: Internal sealings made of FKM, even for standard NBR-type.

V = FKM (Viton®)

(Temperature range -20 °C ... +200 °C / -4 °F ... +392 °F)

E = EPDM Ethylene Propylene Diene Monomer Rubber

(for Brake fluid,

Temperature range -40 °C ... +150 °C / -40 °F ... +302 °F)

Media

- Suitable for hydraulic oils and other Mineral oil based fluids
(Check compatibility of seal material)
- For use with other liquid media please contact STAUFF

SMK-10 Test Coupling with Male Threaded Stud	SMK-10 Type G Test Coupling with Straight 24° Fitting	SMK-10 Type K Test Coupling With 24° Taper / O-ring (DKO)
		

Test Coupling with Male Threaded Stud SMK-10

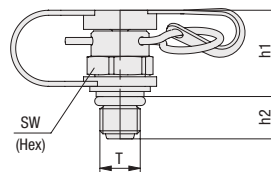

Ordering Codes

SMK-10*-M10x1*-B*-A*-W3

* Type	Test Coupling with Ball Check	SMK
* Series	STAUFF Test 10 Plug In System	-10
* Port Connection	acc. to dimension table	-M10x1
* Seal Material	NBR (Buna-N®) FKM (Viton®) EPDM Seal Type D	-B -V -E none
* Seal Type	O-ring Type A Taper Type D	-A -D
* Material Code	Steel, zinc/nickel-plated Stainless Steel V2A - 1.4305 (AISI 303) Stainless Steel V4A - 1.4571 (AISI 316 Ti)	-W3 -W4 -W5

Thread	Seal Type	Working Pressure (^{bar} / _{psi})	Dimensions (^{mm} / _{in})			Torque (^{Nm} / _{ft-lb}) ca.	Weight (^{kg} / _{lbs}) ca. per 100	Ordering Codes (Standard Option)
			h1	h2	Hex			
M8 x 1	Type A	250	17,5	8,5	12	6	1,50	SMK-10-M8x1-B-A-W3
		3625	.69	.33	.47	4.4	3.30	
M10 x 1	Type A	400	17,5	9,8	12	12	1,70	SMK-10-M10x1-B-A-W3
		5801	.69	.39	.47	8.8	3.74	
R1/8 K	Type D ¹	400	17,5	8	12		1,70	SMK-10-R1/8K-B-W3
		5801	.69	.31	.47		3.74	

¹ Suitable liquid / plastic sealant required.

Alternative materials and surface finishings are available upon request. Contact STAUFF for further information.
Torque recommendations for Steel mating material.

Seal Type



O-ring Type A



Taper Type D¹

For further information on Seal Types, please see page 74-77.

Gauge Adaptor SMA-10

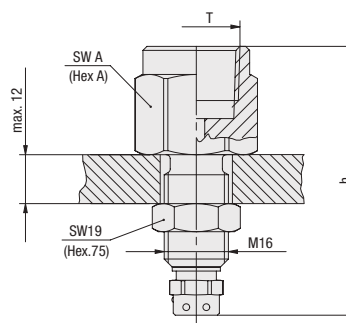

Through hole
Ø 18 (.71)

Ordering Codes

SMA-10*-G1/4*-B*-OR*-W3

* Type	Gauge Adaptor	SMA
* Series	STAUFF Test 10 Plug In System	-10
* Thread	acc. to dimension table	-G1/4
* Seal Material	NBR (Buna-N®) FKM (Viton®) EPDM Seal Type without O-ring	-B -V -E none
* Seal Type	with O-ring	-OR
* Material Code	Steel, zinc/nickel-plated Stainless Steel V2A - 1.4305 (AISI 303) Stainless Steel V4A - 1.4571 (AISI 316 Ti)	-W3 -W4 -W5

Thread	Dimensions (^{mm} / _{in})		Weight (^{kg} / _{lbs}) ca. per 100	Ordering Codes (Standard Option)
	h	Hex A		
G1/4	57	19	7,60	SMA-10-G1/4-B-OR-W3
	2.24	.75	16.72	
G1/2	67	27	12,70	SMA-10-G1/2-B-OR-W3
	2.64	1.06	27.94	
1/4 NPT	57	19	7,40	SMA-10-1/4NPT-W3
	2.24	.75	16.31	
1/2 NPT	67	27	12,70	SMA-10-1/2NPT-W3
	2.64	1.06	27.99	

Standard option: With Hexagon Lock Nut.

Alternative materials and surface finishings are available upon request. Contact STAUFF for further information.
Snubber on request.

Dimensional drawings: All dimensions in mm (in).

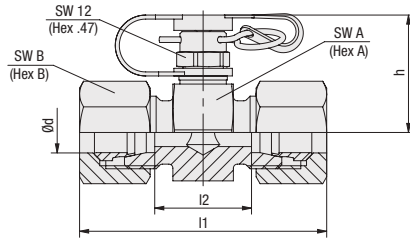
**Test Coupling with Straight 24° Fitting
SMK-10 Type G**
A

Series	PN (bar/PSI)	Pipe Ø d	Dimensions (mm/in)					Weight (kg/lbs) ca. per 100 ¹	Ordering Codes (Standard Option) ²
			~l ³	l2	h	Hex A	Hex B		
L	315 4568	6	51	21	29,5	24	14	9,40	SMK-10-06L-G-W3-MS
			2.01	.83	1.16	.94	.55	20.68	
		8	51	21	29,5	24	17	10,80	SMK-10-08L-G-W3-MS
			2.01	.83	1.16	.94	.67	23.76	
		10	53	23	29,5	24	19	11,90	SMK-10-10L-G-W3-MS
			2.09	.91	1.16	.94	.75	26.18	
		12	53	23	31	27	22	14,70	SMK-10-12L-G-W3-MS
	2.09		.91	1.22	1.06	.87	32.34		
	15	55	25	32,5	30	27	21,20	SMK-10-15L-G-W3-MS	
		2.17	.98	1.28	1.18	1.06	46.64		
	18	57	24	33,5	32	32	27,40	SMK-10-18L-G-W3-MS	
		2.24	.94	1.32	1.26	1.26	60.28		
	160 2320	22	61	28	33,5	36	36	33,90	SMK-10-22L-G-W3-MS
			2.40	1.10	1.32	1.42	1.42	74.74	
28		61	28	38	41	41	40,90	SMK-10-28L-G-W3-MS	
		2.40	1.10	1.50	1.61	1.61	89.98		
35		69	26	40,5	46	50	58,90	SMK-10-35L-G-W3-MS	
	2.72	1.02	1.59	1.81	1.97	129.85			
42	71	25	45	55	60	82,70	SMK-10-42L-G-W3-MS		
S	400 5801	6	55	25	29,5	24	17	12,10	SMK-10-06S-G-W3-MS
			2.17	.98	1.16	.94	.67	26.62	
		8	55	25	29,5	24	19	13,00	SMK-10-08S-G-W3-MS
			2.17	.98	1.16	.94	.75	28.60	
		10	57	24	29,5	24	22	15,40	SMK-10-10S-G-W3-MS
			2.24	.94	1.16	.94	.87	33.88	
		12	57	24	29,5	24	24	16,70	SMK-10-12S-G-W3-MS
			2.24	.94	1.16	.94	.94	36.74	
		14	63	27	31	27	27	22,80	SMK-10-14S-G-W3-MS
			2.50	1.06	1.22	1.06	1.06	50.27	
		16	63	26	32,5	30	30	27,60	SMK-10-16S-G-W3-MS
			2.50	1.02	1.28	1.18	1.18	60.72	
		20	69	26	35,5	36	36	41,90	SMK-10-20S-G-W3-MS
			2.72	1.02	1.40	1.42	1.42	92.18	
25	75	27	38	41	46	68,20	SMK-10-25S-G-W3-MS		
	2.95	1.06	1.50	1.61	1.81	150.04			
30	81	28	40,5	46	50	81,80	SMK-10-30S-G-W3-MS		
	3.19	1.10	1.59	1.81	1.97	179.96			
315 4568	38	91	29	45	55	60	122,70	SMK-10-38S-G-W3-MS	
		3.58	1.14	1.77	2.17	2.36	270.51		

Ordering Codes
***SMK*-10*-18L*-G*-W3*-MS**

* Type	Test Coupling with Ball Check	SMK
* Series	STAUFF Test 10 Plug In System	-10
* Outside Tube Diameter	acc. to dimension table	-18
* Series	Light Series Heavy Series	L S
* Seal Material	FKM (Viton®) EPDM	none -E
* Connection	Straight 24° Fitting	-G
* Material Code	Steel, zinc/nickel-plated	-W3
	Stainless Steel V2A - 1.4305 (AISI 303)	-W4
	Stainless Steel V4A - 1.4571 (AISI 316 Ti)	-W5
* Assembling / Kitting	Fitting body only	-
	Fitting body supplied with Cutting rings and union nuts	-MS
	Fitting body supplied with soft-sealing cutting rings and union nuts	-MSV

¹ Weight including cutting rings and union nuts.

² Standard option: Fitting body supplied with Cutting rings and union nuts.

³ Approximate dimension in assembled condition.

Port acc. to ISO 8434-1 / DIN 2353

Alternative materials and surface finishings are available upon request. Contact STAUFF for further information.

**Test Coupling with 24° Taper / O-ring (DKO)
SMK-10 Type K**

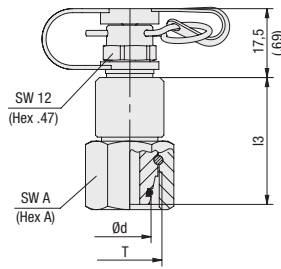

Version A

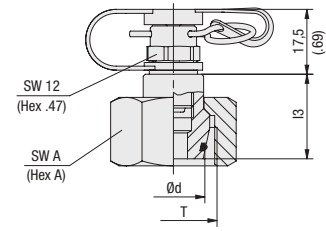

Version B

Ordering Codes

***SMK*-10*-18L*-B*-K*-GS*-W3**

* Type	Test Coupling with Ball Check	SMK
* Series	STAUFF Test 10 Plug In System	-10
* Outside Tube Diameter	acc. to dimension table	-18
* Series	Light Series	L
	Heavy Series	S
* Seal Material	NBR (Buna-N®)	-B
	FKM (Viton®)	-V
	EPDM	-E
* Connection	24° Taper / O-ring (DKO)	-K
* Design	One-piece design (Version A)	-
	Screwed design (Version B)	-GS
* Material Code	Steel, zinc/nickel-plated	-W3
	Stainless Steel V2A - 1.4305 (AISI 303)	-W4
	Stainless Steel V4A - 1.4571 (AISI 316 Ti)	-W5

Series	PN (^{mm} / _{inch})	Pipe $\emptyset d$	Dimensions (^{mm} / _{inch})			Thread	Version	Weight (^{kg} / _{lbs}) ca. per 100	Ordering Codes (Standard Option)
			l3	Hex A	T				
L	315 4568	6	15,5	14	M12 x 1,5	A	4,60	SMK-10-06L-B-K-GS-W3	
			.61	.55			10,12		
		8	15,5	17	M14 x 1,5	A	5,30	SMK-10-08L-B-K-GS-W3	
			.61	.67			11,66		
		10	16,5	19	M16 x 1,5	A	6,50	SMK-10-10L-B-K-GS-W3	
			.65	.75			14,30		
	12	17,5	22	M18 x 1,5	A	8,00	SMK-10-12L-B-K-GS-W3		
		.69	.87			17,60			
	15	21	27	M22 x 1,5	B	8,10	SMK-10-15L-B-K-GS-W3		
		.83	1,06			17,82			
	18	19,5	32	M26 x 1,5	B	10,90	SMK-10-18L-B-K-GS-W3		
		.77	1,26			23,98			
	160 2320	22	20,5	36	M30 x 2	B	15,30	SMK-10-22L-B-K-GS-W3	
			.81	1,42			33,66		
		28	25	41	M36 x 2	B	21,10	SMK-10-28L-B-K-GS-W3	
			.98	1,61			270,51		
35		30	50	M45 x 2	B	35,75	SMK-10-35L-B-K-GS-W3		
		1,18	1,97			78,82			
42	31	60	M52 x 2	B	53,10	SMK-10-42L-B-K-GS-W3			
	1,22	2,36			117,07				
S	400 5801	6	14,5	17	M14 x 1,5	A	5,10	SMK-10-06S-B-K-GS-W3	
			.57	.67			11,22		
		8	16,5	19	M16 x 1,5	A	6,10	SMK-10-08S-B-K-GS-W3	
			.65	.75			13,42		
		10	16,5	22	M18 x 1,5	A	7,80	SMK-10-10S-B-K-GS-W3	
			.65	.87			17,16		
		12	17,5	24	M20 x 1,5	A	9,80	SMK-10-12S-B-K-GS-W3	
			.69	.94			21,56		
		14	19,5	27	M22 x 1,5	B	8,60	SMK-10-14S-B-K-GS-W3	
			.77	1,06			18,92		
		16	18	30	M24 x 1,5	B	10,20	SMK-10-16S-B-K-GS-W3	
			.71	1,18			22,44		
		20	24	36	M30 x 2	B	17,00	SMK-10-20S-B-K-GS-W3	
			.94	1,42			37,40		
25	26	46	M36 x 2	B	30,70	SMK-10-25S-B-K-GS-W3			
	1,02	1,81			67,54				
30	30	50	M42 x 2	B	37,80	SMK-10-30S-B-K-GS-W3			
	1,18	1,97			83,33				
315 4568	38	34	60	M52 x 2	B	59,50	SMK-10-38S-B-K-GS-W3		
		1,34	2,36			131,18			

With 24° Taper / O-ring (DKO) Connection acc. to ISO 8434-1 / DIN 2353
Alternative materials and surface finishings are available upon request. Contact STAUFF for further information.

Special Test Coupling Solutions
STAUFF Test

A



Pressure Test Connection for Compressed-Air Pneumatic Braking Equipment (according to ISO 3583)



Test Coupling with Female Connection Port



Gauge Adaptor with Test Coupling



Banjo Fitting with Test Coupling

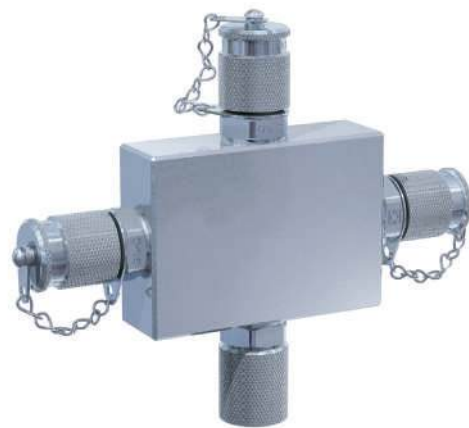

Triple Manifold Block with Test Couplings

Custom-designed test coupling solutions in addition to the Original-STAUFF-Test range according to customers specifications or based on STAUFF developments.

If you have similar requirements please contact STAUFF.



Test Adaptors 54 - 58



Thread Adaptor

56

SRS-20



Thread Adaptor

57

SRS-15



Welding Adaptor

58

SAS



Adjustable Gauge Fitting

58

EMV



Pressure Test Kit

59

B

Thread Adaptor SRS-20

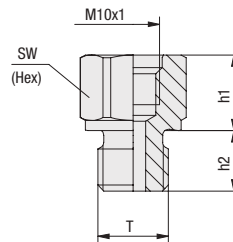

B

Ordering Codes

SRS-20*-M12x1.5*-B*-C*-W3

* Type	Thread Adaptor	SRS
* Series	STAUFF Test 20 (All sizes)	-20
* Port Connection	acc. to dimension table	-M12x1.5
* Seal Material	NBR (Buna-N®)	-B
	FKM (Viton®)	-V
	EPDM	-E
	Seal Type B and D	none
* Seal Type	Metal Joint Type B	-B
	Elastomeric Sealing Type C	-C
	Taper Type D	-D
	O-ring Type E	-E
* Material Code	Steel, zinc/nickel-plated	-W3
	Stainless Steel V2A - 1.4305 (AISI 303)	-W4
	Stainless Steel V4A - 1.4571 (AISI 316 Ti)	-W5

Seal Type



Metal Joint Type B



Elastomeric Sealing Type C



Taper Type D¹



O-ring Type E

For further information on Seal Types, please see page 74-77.

Thread	Seal Type	Dimensions (mm/in)			Weight (kg/lbs) ca. per 100	Ordering Codes (Standard Option)	
		h1	h2	Hex			
T							
M10 x 1	Type B	15,5	8,5	17	2,40	SRS-20-M10x1-B-W3	
		.61	.33	.67	5.28		
M12 x 1,5		15	12	19	3,20	SRS-20-M12x1.5-B-W3	
		.59	.47	.75	7.04		
M14 x 1,5		15	12	19	3,70	SRS-20-M14x1.5-B-W3	
		.59	.47	.75	8.14		
M16 x 1,5		8	12	22	2,80	SRS-20-M16x1.5-B-W3	
		.31	.47	.87	6.16		
M18 x 1,5		15	12	24	6,20	SRS-20-M18x1.5-B-W3	
		.59	.47	.94	13.64		
M22 x 1,5		10,5	14	27	7,20	SRS-20-M22x1.5-B-W3	
		.41	.55	1.06	15.84		
G1/8		15,5	8	17	2,50	SRS-20-G1/8-B-W3	
		.61	.31	.67	5.50		
G1/4		15	12	19	3,50	SRS-20-G1/4-B-W3	
		.59	.47	.75	7.70		
G3/8		10,5	12	22	3,80	SRS-20-G3/8-B-W3	
		.41	.47	.87	8.36		
G1/2		10,5	14	27	6,60	SRS-20-G1/2-B-W3	
		.41	.55	1.06	14.52		
M12 x 1,5	Type C	15	12	19	3,30	SRS-20-M12x1.5-B-C-W3	
		.59	.47	.75	7.28		
M14 x 1,5		15	12	19	3,80	SRS-20-M14x1.5-B-C-W3	
		.59	.47	.75	8.38		
M18 x 1,5		15	12	24	6,70	SRS-20-M18x1.5-B-C-W3	
		.59	.47	.94	8.16		
G1/8		16	8	17	2,90	SRS-20-G1/8-B-C-W3	
		.63	.31	.67	3.39		
G1/4		15	12	19	3,60	SRS-20-G1/4-B-C-W3	
		.59	.47	.75	7.92		
G3/8		10,5	12	22	3,70	SRS-20-G3/8-B-C-W3	
		.41	.47	.87	8.14		
G1/2		10,5	14	27	6,80	SRS-20-G1/2-B-C-W3	
		.41	.55	1.06	14.96		
R1/4 K		Type D ¹	13	12	17	3,20	SRS-20-R1/4K-D-W3
			.51	.47	.67	7.04	
R3/8 K			13	14	19	4,10	SRS-20-R3/8K-D-W3
			.51	.55	.75	9.02	
R1/2 K			8	19	22	5,80	SRS-20-R1/2K-D-W3
			.31	.75	.87	12.76	
1/4 NPT	10		15	17	2,39	SRS-20-1/4NPT-D-W3	
	.39		.59	.67	5.26		
1/2 NPT	8		20	22	5,83	SRS-20-1/2NPT-D-W3	
	.31		.79	.87	12.83		
7/16-20 UNF	Type E		9	9,1	17	2,30	SRS-20-7/16UNF-B-E-W3
			.35	.36	.67	5.06	
1/2-20 UNF			15	9,2	17	2,50	SRS-20-1/2UNF-B-E-W3
			.59	.36	.67	5.50	
9/16-18 UNF			15,5	10	19	3,60	SRS-20-9/16UNF-B-E-W3
			.61	.39	.75	7.92	
7/8-14 UNF			11	16	27	2,50	SRS-20-7/8UNF-B-E-W3
			.43	.63	1.06	5.51	
M14 x 1,5			14,5	11	19	3,90	SRS-20-M14x1.5-B-E-W3
			.57	.43	.75	8.59	
M16 x 1,5		8,5	12,5	22	3,20	SRS-20-M16x1.5-B-E-W3	
		.33	.49	.87	7.04		
M22 x 1,5		10	15	27	7,20	SRS-20-M22x1.5-B-E-W3	
		.39	.59	1.06	15.87		
M27 x 2		10	18,5	32	7,00	SRS-20-M27x2-B-E-W3	
		.39	.73	1.26	15.43		

¹ Suitable liquid / plastic sealant required.

Thread Adaptor
SRS-15

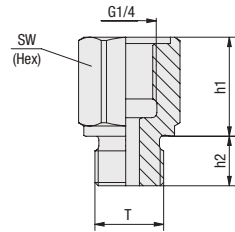

B

Thread T	Seal Type	Dimensions (mm/in)			Weight (^{kg} / _{lbs}) ca. per 100	Ordering Codes (Standard Option)
		h1	h2	Hex		
M14 x 1,5	Type B	24	12	19	5,10	SRS-15-M14x1.5-B-W3
		.95	.47	.75	11.22	
M16 x 1,5		24	12	22	6,70	SRS-15-M16x1.5-B-W3
		.95	.47	.87	14.74	
M18 x 1,5		24	12	24	6,00	SRS-15-M18x1.5-B-W3
		.95	.47	.95	13.20	
M20 x 1,5		10,5	14	27	5,40	SRS-15-M20x1.5-B-W3
		.41	.55	1.06	11.88	
G3/8		24	12	22	7,10	SRS-15-G3/8-B-W3
		.95	.47	.87	15.62	
G1/2		10,5	14	27	5,60	SRS-15-G1/2-B-W3
		.41	.55	1.06	12.32	
M14 x 1,5	Type C	24	12	19	4,60	SRS-15-M14x1.5-B-C-W3
		.95	.47	.75	10.12	
M16 x 1,5		24	12	22	6,60	SRS-15-M16x1.5-B-C-W3
		.95	.47	.87	14.52	
M18 x 1,5		24	12	24	8,10	SRS-15-M18x1.5-B-C-W3
		.95	.47	.95	17.86	
G3/8		24	12	22	6,80	SRS-15-G3/8-B-C-W3
		.95	.47	.87	14.96	

Ordering Codes

***SRS*-15*-M14x1.5*-B*-C*-W3**

* Type	Thread Adaptor	SRS
* Series	STAUFF Test 15 (All sizes)	-15
* Port Connection	acc. to dimension table	-M14x1.5
* Seal Material	NBR (Buna-N®) FKM (Viton®) EPDM Seal Type B	-B -V -E none
* Seal Type	Metal Joint Type B Elastomeric Sealing Type C	-B -C
* Material Code	Steel, zinc/nickel-plated Stainless Steel V2A - 1.4305 (AISI 303) Stainless Steel V4A - 1.4571 (AISI 316 Ti)	-W3 -W4 -W5

Alternative materials and surface finishings are available upon request. Contact STAUFF for further information.

Seal Type



Metal Joint Type B



Elastomeric Sealing Type C

For further information on Seal Types, please see page 74-77.

Welding Adaptor SAS

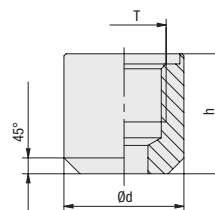

B

Ordering Codes

SAS-M10x1*-W2

* Type	Welding Adaptor	SAS
* Port Connection	acc. to dimension table	-M10x1
* Material Code	Steel, untreated	-W1
	Steel, phosphated	-W2
	Stainless Steel V2A - 1.4305 (AISI 303)	-W4
	Stainless Steel V4A - 1.4571 (AISI 316 Ti)	-W5

Thread	Port Connection	Dimensions (mm/in)		Weight (kg/lbs) ca. per 100	Ordering Codes (Standard Option)
		h	Ød		
M10 x 1	Type A (p. 74)	25	20	4,60	SAS-M10x1-W2
		.98	.79	10,14	
G1/8	Type B/C (p. 75)	25	20	4,70	SAS-G1/8-W2
		.98	.79	10,36	
G1/4	Type B/C (p. 75)	30	22	6,40	SAS-G1/4-W2
		1.18	.87	14,11	
G3/8	Type B/C (p. 75)	30	25	6,90	SAS-G3/8-W2
		1.18	.98	21,16	
1/4 NPT	Type D (p. 76)	25	20	3,80	SAS-1/4NPT-W2
		.98	.79	8,38	
1/2-20 UNF	Type E (p. 77)	25	20	14,00	SAS-1/2UNF-W2
		.98	.79	30,86	

Alternative materials and surface finishings are available upon request. Contact STAUFF for further information.

Adjustable Gauge Fitting EMV

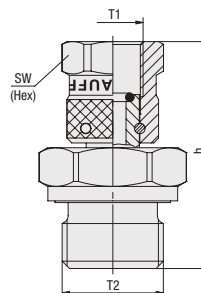

Ordering Codes

EMV-G1/4/G1/2*-B*-OR*-B*-C*-W3

* Type	Adjustable Gauge Fitting	EMV
* Port Connection	acc. to dimension table	-G1/4/G1/2
* Seal Material	NBR (Buna-N®)	-B
	FKM (Viton®)	-V
	EPDM	-E
* Seal Type (Female)	with O-ring	-OR
* Seal Material	NBR (Buna-N®)	-B
* Seal Type	Elastomeric Sealing Type C	-C
* Material Code	Steel, zinc/nickel-plated	-W3
	Stainless Steel V2A - 1.4305 (AISI 303)	-W4
	Stainless Steel V4A - 1.4571 (AISI 316 Ti)	-W5

Dimensions (mm/in)				Weight (kg/lbs) ca. per 100	Ordering Codes (Standard Option)
T1	T2	h	Hex		
G1/4	G1/4	42	19	6,20	EMV-G1/4-B-OR-B-C-W3
		1.65	.75	13,64	
G1/4	G1/2	47	19	11,10	EMV-G1/4/G1/2-B-OR-B-C-W3
		1.85	.75	24,42	
G1/2	G1/4	51	27	13,00	EMV-G1/2/G1/4-B-OR-B-C-W3
		2.01	1.06	28,60	
G1/2	G1/2	55,5	27	18,00	EMV-G1/2-B-OR-B-C-W3
		2.19	1.06	39,60	

Alternative materials and surface finishings are available upon request. Contact STAUFF for further information.

Pressure Test Kit (analog) SMB



SMB-20-3-xxx/xxx-W3 or SMB-15-3-xxx/xxx-W3

SMB-20/100-1-xxx-W3 or SMB-15/100-1-xxx-W3

In addition to the individual SPG gauges, the STAUFF Pressure Gauges are also available as a part of a Pressure Test Kit SMB.

The SMB Pressure Test Kits are assembled in various versions, in accordance with customer wishes.

All Pressure Test Kits are supplied in a handy case with custom-designed foam inserts.

Further information on these products and components please see Catalogue 8 - STAUFF Diagtronics.

Note: All test kits are available as SMB-15 version.

B

Pressure Test Kit (digital) SMB-DIGI



SMB-DIGI

In addition to the individual SPG-DIGI devices, the STAUFF Digital Pressure Gauges are also available as a part of a Pressure Test Kit SMB-DIGI.

The SMB-DIGI Pressure Test Kits are assembled in various versions, in accordance with customer wishes.

All Pressure Test Kits are supplied in a handy case with custom-designed foam inserts.

Further information on these products and components please see Catalogue 8 - STAUFF Diagtronics.

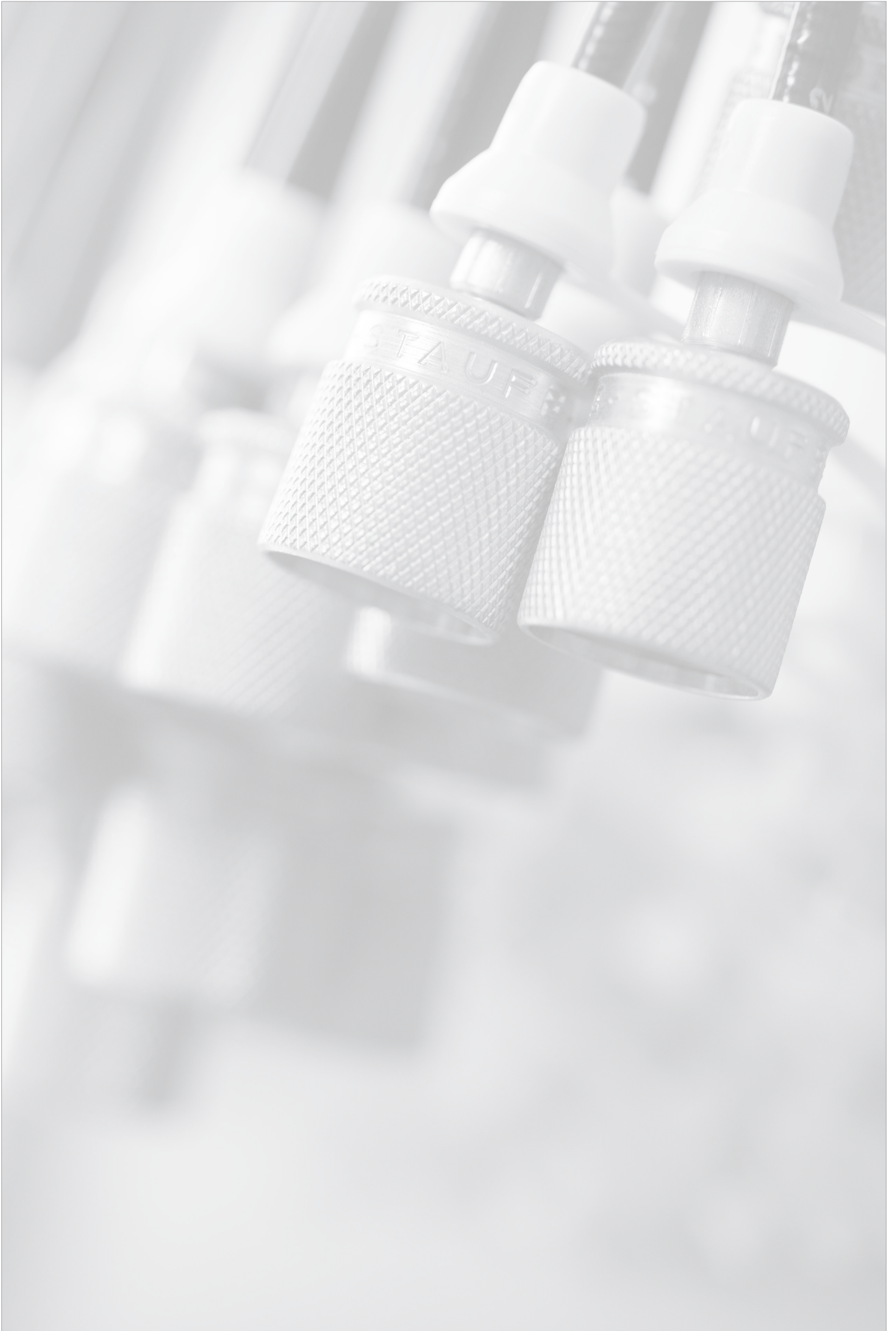

Test Hoses and Connectors 60 - 70

Test Hose SMS / SGS 62 - 63

Technical Data



Test Hose / Hose End SMS / SGS / HE 63

Ordering Codes



Hose End HE 64 - 69



Hose Connector SSV 70



Sampling Hose Adaptor SHA 70

Technical Data Test Hose



		A	B	C	D
Nominal Bore (DN)	(mm)	DN 2		DN 4	
Max. Working Pressure (PN)	(bar / PSI)	400 / 5801	630 / 9135	340 / 4931	630 / 9135
Min. Burst Pressure	(bar / PSI)	1100 / 15954	1900 / 27557	850 / 12328	1900 / 27557
Testing Pressure	(bar / PSI)	600 / 8702	950 / 13778	570 / 8267	950 / 13779
Pressure Rating in bar / PSI at Indicated Temperature	at 0 °C / 32 °F (122 %)	488 / 7077	768 / 11139	415 / 6016	768 / 11139
	at 30 °C / 86 °F (110 %)	440 / 6381	693 / 10051	374 / 5424	693 / 10051
	at 50 °C / 122 °F (100 %)	400 / 5801	630 / 9137	340 / 4931	630 / 9137
	at 80 °C / 176 °F (86 %)	344 / 4989	542 / 7861	292 / 4241	542 / 7861
	at 100 °C / 212 °F (77 %)	308 / 4467	485 / 7034	262 / 3797	485 / 7034
Working Temperature	(°C / °F)	-35 °C ... +100 °C / -31 °F ... +212 °F (momentary +120 °C / +248 °F)			
Inside Diameter	(mm / in)	2 / .08			
Outside Diameter	(mm / in)	5 / .20			
Bending Radius ¹	at working pressure	(mm / in) 20 / .79			
	at -20 °C / 4 °F	(mm / in) 30 / 1.18			
Max. Coil Length	(m / ft)	20 / 65.62			
Weight / m	(g / oz)	16 / .50			
Inner / Outer Tube		PA			
Reinforcement		Synthetic Fibre			
Standard hose end material is Steel 11 S Mn Pb 30 (1.0718), zinc/ nickel-plated (Type 15: Steel, black zinc/nickel-plated)					
Stainless Steel: V2A (1.4305/AISI 303), V4A (1.4571/AISI 316Ti) on request					

¹ Note: During mounting make sure that the bending radius for the test hose does not fall below the smallest permissible value.

STAUFF Test Hoses (Selection)

STAUFF-Test 20/20

STAUFF-Test 15/15

STAUFF-Test 12/12²

STAUFF-Test 10/10

Gauge Adaptor



² Special thread: buttress thread S12,65 x 1,5



Ordering Codes STAUFF Test Hose

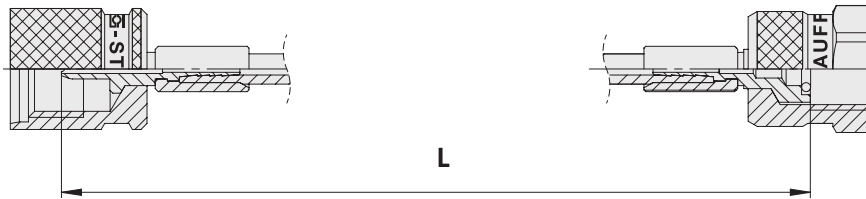

SMS¹	20	/ M	3000	A	W3	
Hose End 1 (see page 64 - 69)		Hose End 2 (see page 64 - 69)		Length	DN	Material Hose End
20	A	J	only specify when 2 different hose ends are required	Length mm (*see L above) Standard Length see table below.	A = DN 2 400 bar / 5802 PSI B = DN 2 630 bar / 9137 PSI C ² = DN 4 340 bar / 4931 PSI D ² = DN 4 630 bar / 9137 PSI	Standard hose end material is Steel 11 S Mn Pb 30 (1.0718), zinc/nickel-plated = W3 Type 15: Steel, <u>black</u> zinc/nickel-plated = W3 Stainless Steel: V2A (1.4305/AISI 303) = W4, on request V4A (1.4571/AISI 316Ti) = W5, on request
15	S	D				
12	K	B				
10	L	U				
M	G	P				
N	F	etc.				
W	C					
¹ for gaseous media type SGS - Test hoses are perforated						
² Type C and D - are perforated						

C

Standard Length L*	
mm	in
200	7.87
400	15.75
630	24.80
800	31.50
1000	39.37
1500	59.06
2000	78.74
2500	98.43
3200	125.98
4000	157.48



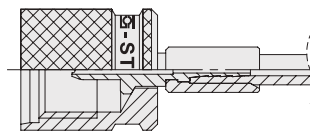

Ordering Codes Hose End

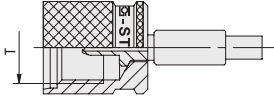
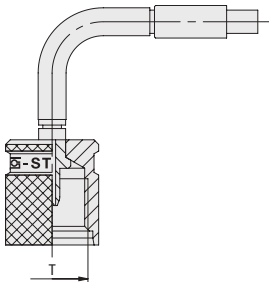
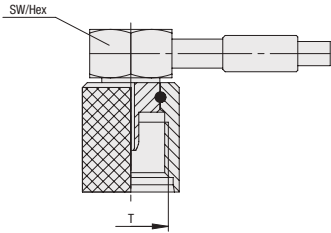

HE	20	A	W3
Hose End (see page 64 - 69)		DN	Material Hose End
20	A	J	Standard hose end material is Steel 11 S Mn Pb 30 (1.0718), zinc/nickel-plated = W3 Type 15: Steel, <u>black</u> zinc/nickel-plated = W3 Stainless Steel: V2A (1.4305/AISI 303) = W4, on request V4A (1.4571/AISI 316Ti) = W5, on request
15	S	D	
12	K	B	
10	L	U	
M	G	P	
N	F	etc.	
W	C		
		A = DN 2 C = DN 4	

STAUFF Hose End

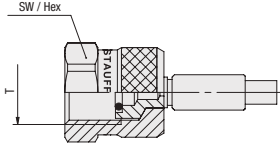
Hose End	Description	T	Hex (mm / in)	DN	Working Pressure (bar / psi) ¹	Type		
	STAUFF-Test Screw-type suitable for test points	M16 x 2	2 and 4	630 / 9137	20			
		M16 x 1,5				15		
		S12,65 x 1,5				12		
	STAUFF-Test Screw-type 90° elbow suitable for test points	M16 x 2	2	630 / 9137	0	20		
		M16 x 1,5				15		
		S12,65 x 1,5				12		
	STAUFF-Test Screw-type 90° elbow suitable for test points (short wire version)	M16 x 2	17 .67	2	630 / 9137	OX	20	
		M16 x 1,5					15	
		S12,65 x 1,5					12	
	STAUFF-Test Plug in-type	Plug In System		2	400 / 5801		10	
	Gauge adaptor BSP-thread for G3/8, G1/2, M14 x 1,5 and M20 x 1,5 swivel nut like type N	G1/4	19 27 22 19 27	.75 1.06 .87 .75 1.06	2 and 4	630 / 9137	M	1/4
		G1/2						1/2
		G3/8						3/8
		M14 x 1,5						14
		M20 x 1,5						20

¹The indicated working pressure applies only to the Hose End. The actual working pressure depends on the Test Hose used.

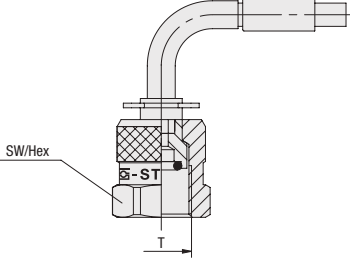
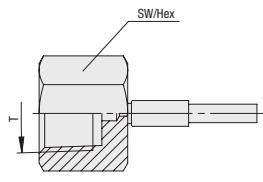
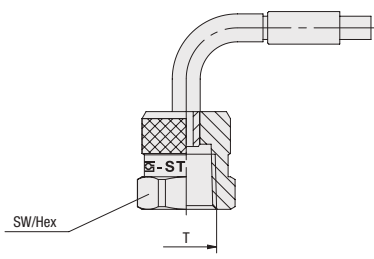
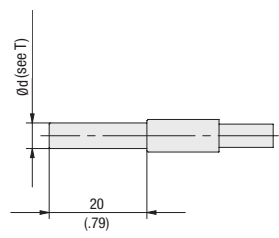
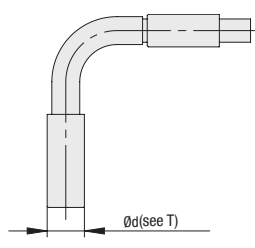
Hose End	Description	T	Hex (mm / in)	DN	Working Pressure (^{bar} / ^{PSI}) ¹	Type	
	90° elbow gauge adaptor BSP-thread for G1/2 swivel nut like type N	G1/4	19	.75	630 / 9137	W	
		G1/2	27	1.06			
	Gauge adaptor NPT-thread for 1/4 NPT swivel nut like type M	1/4 NPT	19	.75	2	N	
		1/2 NPT	27	1.06			
	90° elbow gauge adaptor NPT-thread for 1/2 NPT swivel nut like type N	1/4 NPT	19	.75	2 and 4	A	
		1/2 NPT	27	1.06			
	Standpipe for compression ring fittings according to ISO 8434-1 / DIN 2353 Note: Standpipe version is not in accordance with the state of the art. Use at own risk. We recommend the use of the series K, R or L.	4 LL			2	04	
		6 L - 6 S			630 / 9137	S	06
		8 L - 8 S		2 and 4			08
		10 L - 10 S					10
		12 L - 12 S		2			12
		1/4		2 and 4	1/4		
	Standpipe for compression ring fittings according to ISO 8434-1 / DIN 2353 90° elbow Note: Standpipe version is not in accordance with the state of the art. Use at own risk. We recommend the use of the series K, R or L.	6 L - 6 S			2 and 4	630 / 9137	06
		8 L - 8 S					08

¹ The indicated working pressure applies only to the Hose End. The actual working pressure depends on the Test Hose used.

STAUFF Hose End

Hose End	Description	T	Hex (mm/in)	DN	Working Pressure (^{bar} /PSI) ¹	Type	
	Seal with O-ring for 24° cone fitting according to ISO 8434-1 / DIN 2353 c/w swivel nut	M12 x 1,5	14 .55	2 and 4	315 / 4568	K	06L
		M14 x 1,5	17 .67				08L
		M16 x 1,5	19 .75				10L
		M18 x 1,5	22 .87				12L
		M14 x 1,5	17 .67		630 / 9137	06S	
		M16 x 1,5	19 .75			08S	
		M18 x 1,5	22 .87			10S	
		M20 x 1,5	24 .94			12S	
	Seal with O-ring for 24° cone fitting according to ISO 8434-1 / DIN 2353 c/w swivel nut 45° elbow	M12 x 1,5	14 .55	2 and 4	315 / 4568	R	06L
		M14 x 1,5	14 .67				06S
	Seal with O-ring for 24° cone fitting according to ISO 8434-1 / DIN 2353 c/w swivel nut 90° elbow	M12 x 1,5	14 .55	2 and 4	315 / 4568	L	06L
		M14 x 1,5	17 .67				08L
		M16 x 1,5	19 .75				10L
		M14 x 1,5	17 .67		630 / 9137		06S
		M16 x 1,5	19 .75				08S
		M18 x 1,5	24 .94				10S
	Male thread according to DIN 3852-B	M12 x 1,5	17 .67	2 and 4	630 / 9137	G	12
		G1/8	14 .55		400 / 5801		1/8
		G1/4	19 .75		630 / 9137		1/4
		G1/2	27 1.06		630 / 9137		1/2
	Male thread NPT according to ANSI-standard	1/8 NPT	13 .51	2 and 4	400 / 5801	F	1/8
		1/4 NPT	17 .67		630 / 9137		1/4

¹The indicated working pressure applies only to the Hose End. The actual working pressure depends on the Test Hose used.

Hose End	Description	T	Hex (mm/in)	DN	Working Pressure (bar/PSI) ¹	Type	
	Male thread for 24° cone fitting according to ISO 8434-1 / DIN 2353	M12 x 1,5	14 .55	2 and 4	315 / 4568	C	06L
		M14 x 1,5	17 .67				08L
		M14 x 1,5	17 .67		630 / 9137	06S	
		M16 x 1,5	17 .67			08S	
	Male thread according to SAE J 514	7/16-20 UNF	14 .55	2 and 4	350 / 5076	J	1/4
		1/2-20 UNF	14 .55				5/16
		9/16-18 UNF	17 .67				3/8
	Universal sealing head with swivel nut for 24° cone fitting according to ISO 8434-1 / DIN 2353	M12 x 1,5	14 .55	2 and 4	315 / 4568	D	06L
		M14 x 1,5	17 .67				08L
		M16 x 1,5	19 .75				10L
		M18 x 1,5	22 .87				12L
		M14 x 1,5	17 .67		630 / 9137	06S	
		M16 x 1,5	19 .75			08S	
		M18 x 1,5	22 .87			10S	
		M20 x 1,5	24 .94			12S	
	Universal sealing head with swivel nut for 24° cone fitting according to ISO 8434-1 / DIN 2353 90° elbow	M16 x 1,5	19 .75	2 and 4	315 / 4568	Q	10L
		M18 x 1,5	22 .87				630 / 9137
	Sealing head with swivel nut for cone fitting according to DIN EN 560	G1/8	12 .47	2		B	1/8
		G1/4	17 .67	2 and 4			1/4

¹ The indicated working pressure applies only to the Hose End. The actual working pressure depends on the Test Hose used.

STAUFF Hose End

Hose End	Description	T	Hex (mm / in)	DN	Working Pressure (^{bar} / ^{PSI}) ¹	Type
	Sealing head with swivel nut according to SAE J 514 37° cone	7/16–20 UNF	14 .55	2 and 4	350 / 5076	1/4
		1/2–20 UNF	17 .67			5/16
		9/16–18 UNF	19 .75			3/8
	Sealing head with swivel nut according to SAE J 516 45° cone	7/16–20 UNF	14 .55	2		UR 1/4
	Sealing head with swivel nut according to SAE J 514 37° cone 90° elbow	7/16–20 UNF	14 .55	2 and 4	350 / 5076	E 1/4
	Sealing head with swivel nut according to SAE J 516 45° cone 90° elbow	7/16–20 UNF	14 .55	2		ER 1/4
	Test hose for air brake systems according to ISO 3583	M16 x 1,5	19 .75	2		P 02

¹The indicated working pressure applies only to the Hose End. The actual working pressure depends on the Test Hose used.

Hose End	Description	T	Hex (mm / in)	DN	Working Pressure (bar / psi) ¹	Type
	Sealing head with swivel nut 60° cone	G1/4	17 .67	2 and 4	630 / 9137	H 1/4
	Screw-type ORFS according to SAE J 1453	9/16-18 UNF	17 .67	2	/	T 9/16
		11/16-16 UN	21 .83			T 11/16
	Screw-type ORFS according to SAE J 1453 90° elbow	11/16-16 UN	21 .83	2 and 4	/	V 11/16
	Hose end with integrated check valve	M16 x 2	/	2	630 / 9137	RV 20
		M16 x 1,5				RV 15

C

¹ The indicated working pressure applies only to the Hose End. The actual working pressure depends on the Test Hose used.

Hose Connector SSV

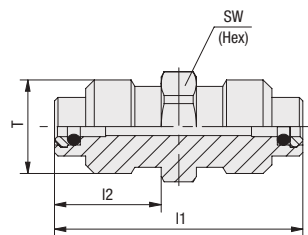

C

Ordering Codes

SSV-20*-W3

* Type	Hose Connector	SSV
* Series	STAUFF Test 20	-20
	STAUFF Test 15	-15
	STAUFF Test 12	-12
* Material Code	Steel, zinc/nickel-plated	-W3
	Stainless Steel V2A - 1.4305 (AISI 303)	-W4
	Stainless Steel V4A - 1.4571 (AISI 316 Ti)	-W5

Thread	Dimensions (mm/in)			Hex	Weight (kg/lbs) ca. per 100	Ordering Codes (Standard Option)
	I1	I2				
M16 x 2	42,5	18,5	17	4,60	SSV-20-W3	
	1.67	.73	.67	10.12		
M16 x 1,5	42,5	18,5	17	4,79	SSV-15-W3	
	1.67	.73	.67	10.54		
S12,65 x 1,5	31	12,5	14	2,50	SSV-12-W3	
	1.22	.49	.55	5.50		

Alternative materials and surface finishings are available upon request. Contact STAUFF for further information.

Sampling Hose Adaptor SHA

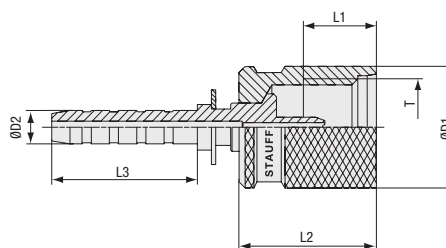

Ordering Codes

SHA-20*-5.5MM*-W3

* Type	Sampling Hose Adaptor	SHA
* Series	STAUFF Test 20	-20
* Size	Hose nipples	-5.5MM
* Material Code	Steel, zinc/nickel-plated	-W3
	Stainless Steel V2A - 1.4305 (AISI 303)	-W4
	Stainless Steel V4A - 1.4571 (AISI 316 Ti)	-W5

Dimensions (mm/in)						Weight (kg/lbs) ca. per 100	Ordering Codes (Standard Option)
Ød1	Ød2	I1	I2	I3	T		
22	5,5	13	23	24	M16 x 2	3,36	SHA-20-5.5MM-W3
.87	.22	.51	.91	.94		7.39	

Alternative materials and surface finishings are available upon request. Contact STAUFF for further information.

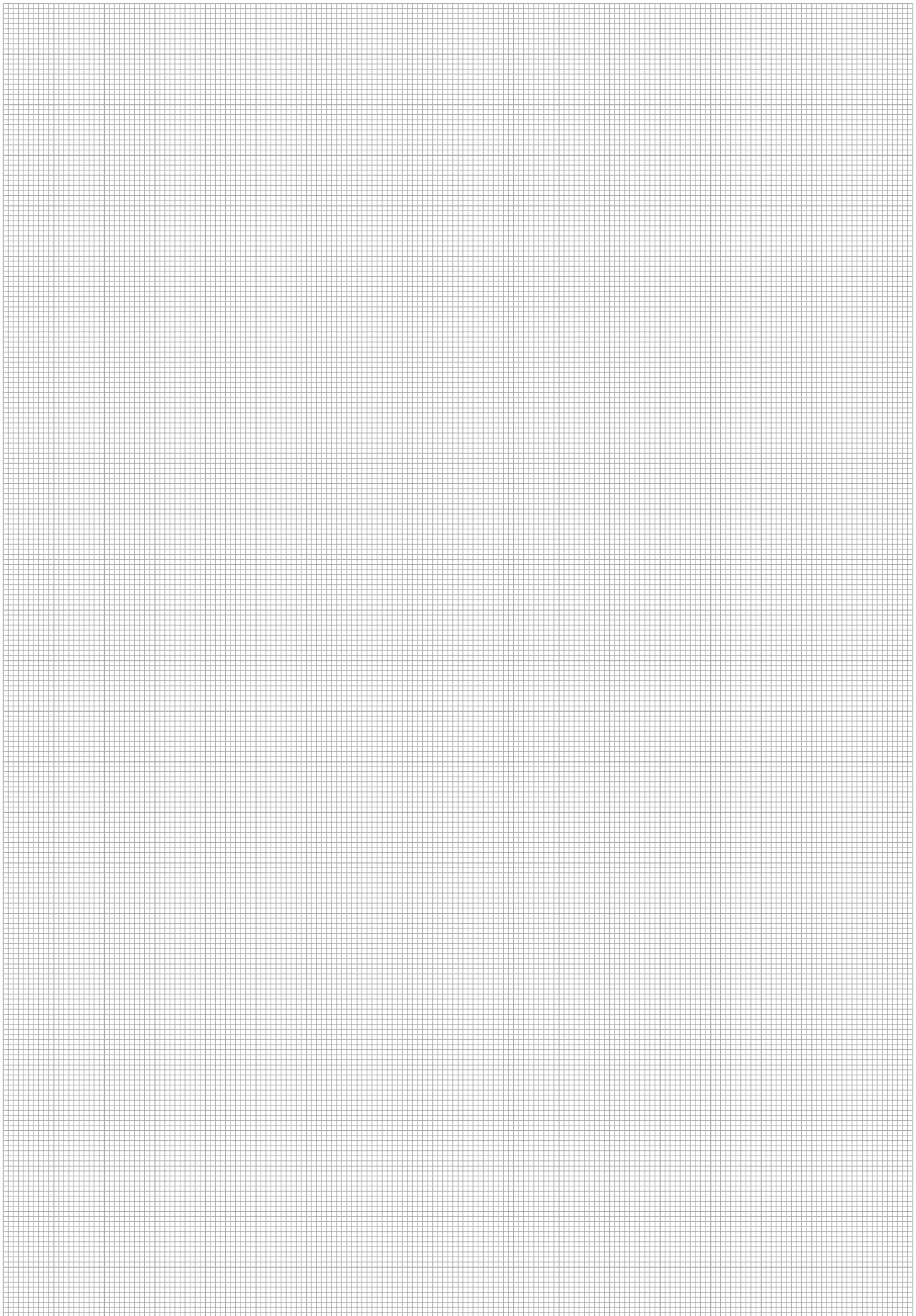



Port Dimensions and Seal Types 74 - 77

Type A 74

Type B 75

Type C 75

Type D 76

Type E 77

D

Port Dimensions and Seal Types

D

Type A

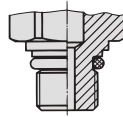

with O-ring

Factory standard

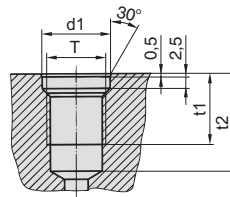

Port Factory standard

Type A

Dimensions

(mm/in)

Thread T	d1 +0,1	t1 min.	t2 min.
M8 x 1	9,5 .37	11 .43	15,5 .61
M10 x 1	11,5 .45	12 .47	16,5 .64

Port Dimensions and Seal Types

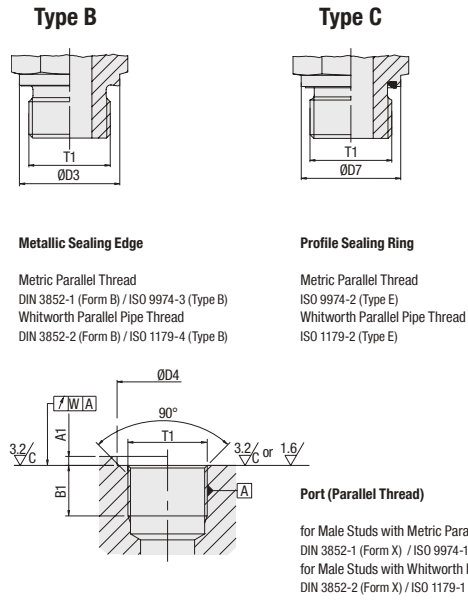
Dimensions

(mm/in)

Thread T1 ¹	D3	D7 _{-0,2}	D4 small _{min}	D4 wide _{min}	A1 _{max}	B1 _{min}	W
M 10 x 1	14 .55	13,9 .55	15 .59	20 .79	1 .04	8 .31	0,1 .0039
M 12 x 1,5	17 .67	16,9 .67	18 .71	25 .98	1,5 .06	12 .47	0,1 .0039
M 14 x 1,5	19 .75	18,9 .74	20 .79	25 .98	1,5 .06	12 .47	0,1 .0039
M 16 x 1,5	21 .83	21,9 .86	23 .91	28 1.10	1,5 .06	12 .47	0,1 .0039
M 18 x 1,5	23 .91	23,9 .94	25 .98	30 1.18	2 .08	12 .47	0,1 .0039
M 20 x 1,5	24 .94	25,9 1.02	27 1.06	34 1.34	2 .08	14 .55	0,1 .0039
M 22 x 1,5	27 1.06	26,9 1.06	28 1.10	34 1.34	2,5 .10	14 .55	0,1 .0039
G 1/8 A	14 .55	13,9 .55	15 .59	19 .75	1 .04	8,5 .33	0,1 .0039
G 1/4 A	18 .71	18,9 .74	20 .79	25 .98	1,5 .06	12,5 .49	0,1 .0039
G 3/8 A	22 .87	21,9 .86	23 .91	28 1.10	2 .08	12,5 .49	0,1 .0039
G 1/2 A	26 1.02	26,9 1.06	28 1.10	34 1.34	2,5 .10	15 .59	0,1 .0039

¹ Appendix A in the thread description does not apply to (female) threaded ports.

Port Dimensions and Seal Types

D

Type D

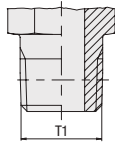

Taper Thread

National Pipe Thread (NPT)
ANSI/ASME B1.20.1-1983

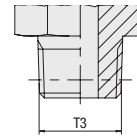

Taper Thread

Metric Taper Thread
DIN 3852-1 (Form C)
Whitworth Taper Pipe Thread
DIN 3852-2 (Form C)

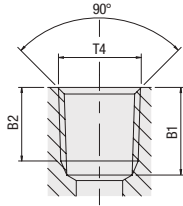

Port (Taper Thread)

for Male Studs with National Pipe NPT Thread
ANSI/ASME B1.20.1-1983

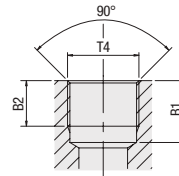

Port (Parallel Thread)

for Male Studs with Metric Taper Thread
DIN 3852-1 (Form Z)
for Male Studs with Whitworth Taper Pipe Thread
DIN 3852-2 (Form Z)

Dimensions

(mm/in)

Thread T1	Thread T3	Thread T4	B1 _{min}	B2 _{min}
1/8-27 NPT		1/8-27 NPT		6,9 .27
1/4-18 NPT		1/4-18 NPT		10 .39
1/2-14 NPT		1/2-14 NPT		13,6 .54
	R 1/8 keg.	Rp 1/8	8,5 .33	5,5 .22
	R 1/4 keg.	Rp 1/4	12,5 .49	8,5 .33
	R 3/8 keg.	Rp 3/8	12,5 .49	8,5 .33
	R 1/2 keg.	Rp 1/2	16,5 .65	10,5 .41

Suitable liquid / plastic sealant required to achieve leak-tightness.

Port Dimensions and Seal Types

Type E

O-ring without Retaining Ring (Non-Adjustable)

Metric Parallel Thread
ISO 6149-2/-3
UN/UNF Thread
ISO 11926-2/-3

Port (Parallel Thread)

for Male Studs with Metric Parallel Thread
ISO 6149-1
for Male Studs with UN/UNF Thread
ISO 11926-1

Ports with Metric Parallel Thread marked with M (optional)

Dimensions										
(mm/in)										
Thread T1 ¹	D5	D4 small _{min}	D4 wide _{min}	D2 _{+0,1 (UNF: ±0,05)}	A1 _{max}	A2 _{+0,4}	B1 _{min}	B2 _{min}	W _{±1*}	
M 10 x 1	13,8	16	20	11,1	1	1,6	11,5	10	12	
	.54	.63	.79	.44	.04	.06	.45	.39	.47	
M 12 x 1,5	16,8	19	23	13,8	1,5	2,4	14	11,5	15	
	.66	.75	.91	.54	.06	.09	.55	.45	.59	
M 14 x 1,5	18,8	21	25	15,8	1,5	2,4	14	11,5	15	
	.74	.83	.98	.62	.06	.09	.55	.45	.59	
M 16 x 1,5	21,8	24	28	17,8	1,5	2,4	15,5	13	15	
	.86	.94	1.10	.70	.06	.09	.61	.51	.59	
M 22 x 1,5	26,8	29	33	23,8	2	2,4	18	15,5	15	
	1.06	1.14	1.30	.94	.08	.09	.71	.61	.59	
M 27 x 2	31,8	34	40	29,4	2	3,1	22	19	15	
	1.25	1.34	1.57	1.16	.08	.12	.87	.75	.59	
5/16-24 UNF-2A	11,1	17		9,1	1,6	1,9	10	12	12	
	.43	.66		.35	.06	.07	.39	.47	.47	
7/16-20 UNF-2A	14,4	21		12,45	1,6	2,4	14	11,5	12	
	.57	.83		.49	.06	.09	.55	.45	.47	
1/2-20 UNF-2A	16	23		14,05	1,6	2,4	14	11,5	12	
	.63	.91		.55	.06	.09	.55	.45	.47	
9/16-18 UNF-2A	17,6	25		15,7	1,6	2,5	15,5	12,7	12	
	.69	.98		.62	.06	.10	.61	.50	.47	
3/4-16 UNF-2A	21,8	30		20,65	2,4	2,5	17,5	14,3	15	
	.86	1.18		.81	.09	.10	.69	.56	.59	
7/8-14 UNF-2A	26,8	34		24,0	2,4	2,5	20	16,7	15	
	1,06	1.34		.94	.09	.10	.79	.66	.59	

¹ Appendix -2B instead of -2A applies for (female) threaded ports.



Product-Specific Abbreviations

Abbreviation	Product Category	Product Description	Page
EMV	Test Adaptors	Adjustable Gauge Fitting	59
HE	Test Hoses and Connectors	STAUFF Test Screw-type	64
HE	Test Hoses and Connectors	STAUFF Test Plug in-type	64
HE-A	Test Hoses and Connectors	Gauge adaptor NPT-thread, 90° elbow, Hose End	65
HE-B	Test Hoses and Connectors	Sealing head with swivel nut for cone fitting according to DIN EN 560, Hose Ends	67
HE-C	Test Hoses and Connectors	Male thread for 24° cone fitting according to ISO 8434-1 / DIN 2353, Hose End	67
HE-D	Test Hoses and Connectors	Universal sealing head with swivel nut for 24° cone fitting according to ISO 8434-1 / DIN 2353, Hose End	67
HE-E	Test Hoses and Connectors	Sealing head with swivel nut according to SAE J 514, 37° cone, 90° elbow, Hose End	68
HE-ER	Test Hoses and Connectors	Sealing head with swivel nut according to SAE J 516, 45° cone, 90° elbow, Hose End	68
HE-F	Test Hoses and Connectors	Male thread NPT according to ANSI Standard, Hose End	66
HE-G	Test Hoses and Connectors	Male thread according to DIN 3852-B, Hose End	66
HE-H	Test Hoses and Connectors	Sealing head with swivel nut, 60° cone, Hose End	69
HE-J	Test Hoses and Connectors	Male thread according to SAE J 514, Hose End	67
HE-K	Test Hoses and Connectors	Seal with O-ring for 24° cone fitting according to ISO 8434-1 / DIN 2353, c/w swivel nut, Hose End	66
HE-L	Test Hoses and Connectors	Seal with O-ring for 24° cone fitting according to ISO 8434-1 / DIN 2353, c/w swivel nut, 90° elbow, Hose End	66
HE-M	Test Hoses and Connectors	Gauge adaptor BSP-thread, Hose End	64
HE-N	Test Hoses and Connectors	Gauge adaptor NPT-thread, Hose End	65
HE-O	Test Hoses and Connectors	STAUFF Test Screw-type, 90° elbow, suitable for test points, Hose End	64
HE-OX	Test Hoses and Connectors	STAUFF Test Screw-type, 90° elbow, suitable for test points (short wire version), Hose End	64
HE-P	Test Hoses and Connectors	Test hose for air brake systems, Hose End	68
HE-Q	Test Hoses and Connectors	Universal sealing head with swivel nut for 24° cone fitting according to ISO 8434-1 / DIN 2353, 90° elbow, Hose End	67
HE-R	Test Hoses and Connectors	Seal with O-ring for 24° cone fitting according to ISO 8434-1 / DIN 2353, c/w swivel nut, 45° elbow, Hose End	66
HE-RV	Test Hoses and Connectors	Hose End with integrated check valve, Hose End	69
HE-S	Test Hoses and Connectors	Standpipe for compression ring fittings according to ISO 8434-1 / DIN 2353, Hose End	65
HE-SG	Test Hoses and Connectors	Standpipe for compression ring fittings according to ISO 8434-1 / DIN 2353, 90° elbow, Hose End	65
HE-T	Test Hoses and Connectors	Screw-type ORFS according to SAE J 1453, Hose End	69
HE-U	Test Hoses and Connectors	Sealing head with swivel nut according to SAE J 514, 37° cone, Hose End	68
HE-UR	Test Hoses and Connectors	Sealing head with swivel nut according to SAE J 516, 45° cone, Hose End	68
HE-V	Test Hoses and Connectors	Screw-type ORFS according to SAE J 1453, 90° elbow, Hose End	69
HE-W	Test Hoses and Connectors	Gauge adaptor BSP-thread, 90° elbow, Hose End	65
SAD-12	Test Coupling STAUFF Test 12	Test Adaptor	46
SAD-15	Test Coupling STAUFF Test 15	Test Adaptor	38
SAD-20	Test Coupling STAUFF Test 20	Test Adaptor	24
SAS	Test Adaptors	Welding Adaptor	58
SGS	Test Hoses and Connectors	Test Hose	63
SGV-JIC Type FM	Test Coupling STAUFF Test 20	Swivel Run Tee with 37° JIC Connection	22
SGV-JIC Type FM	Test Coupling STAUFF Test 15	Swivel Run Tee with 37° JIC Connection	37
SGV-JIC Type FM	Test Coupling STAUFF Test 12	Swivel Run Tee with 37° JIC Connection	45
SHA	Test Hoses and Connectors	Sampling Hose Adaptor	70
SKK-12	Test Coupling STAUFF Test 12	Test Coupling with Male Threaded Stud	42
SKK-12 Type G	Test Coupling STAUFF Test 12	Test Coupling with Straight 24° Fitting	43
SKK-12 Type K	Test Coupling STAUFF Test 12	Test Coupling with 24° Taper / O-ring (DKO)	44
SSK-15	Test Coupling STAUFF Test 15	Bulkhead	37
SKK-20	Test Coupling STAUFF Test 20	Test Coupling with Male Threaded Stud	28
SKK-20 Type G	Test Coupling STAUFF Test 20	Test Coupling with Straight 24° Fitting	29
SKK-20 Type K	Test Coupling STAUFF Test 20	Test Coupling with 24° Taper / O-ring (DKO)	31
SMA-10	Test Coupling STAUFF Test 10	Gauge Adaptor	50
SMA-12	Test Coupling STAUFF Test 12	Gauge Adaptor	46
SMA-15	Test Coupling STAUFF Test 15	Gauge Adaptor	38
SMA-20	Test Coupling STAUFF Test 20	Gauge Adaptor	25
SMD-12	Test Coupling STAUFF Test 12	Direct Gauge Adaptor	46
SMD-15	Test Coupling STAUFF Test 15	Direct Gauge Adaptor	38
SMD-20	Test Coupling STAUFF Test 20	Direct Gauge Adaptor	25
SMK-10	Test Coupling STAUFF Test 10	Test Coupling with Male Threaded Stud	50
SMK-10 Type G	Test Coupling STAUFF Test 10	Test Coupling with Straight 24° Fitting	51
SMK-10 Type K	Test Coupling STAUFF Test 10	Test Coupling with 24° Taper / O-ring (DKO)	52
SMK-15	Test Coupling STAUFF Test 15	Test Coupling with Male Threaded Stud	34
SMK-15 Type G	Test Coupling STAUFF Test 15	Test Coupling with Straight 24° Fitting	35
SMK-15 Type K	Test Coupling STAUFF Test 15	Test Coupling with 24° Taper / O-ring (DKO)	36
SMK-20	Test Coupling STAUFF Test 20	Test Coupling with Male Threaded Stud	16
SMK-20 Type G	Test Coupling STAUFF Test 20	Test Coupling with Straight 24° Fitting	17
SMK-20 Type K	Test Coupling STAUFF Test 20	Test Coupling with 24° Taper / O-ring (DKO)	19
SMK-20 Type ORFS	Test Coupling STAUFF Test 20	Test Coupling with ORFS Connection	23
SMK-20-JIC Type G	Test Coupling STAUFF Test 20	Test Coupling with Straight 37° JIC Connection	21
SMK-20-JIC Type K	Test Coupling STAUFF Test 20	Test Coupling with 37° JIC Connection	20
SMS	Test Hoses and Connectors	Test Hose	63
SRS-15	Test Adaptors	Thread Adaptor	57
SRS-20	Test Adaptors	Thread Adaptor	56
SSK-20	Test Coupling STAUFF Test 20	Bulkhead	24
SSKK-12	Test Coupling STAUFF Test 12	Bulkhead	45
SSV	Test Hoses and Connectors	Hose Connector	70

